

August 27, 1959

To Vice President Sarruf,

With the compliments of the
Medical Students' Society
and the Caducus Editorial
Board.

H. Babigian
Editor.

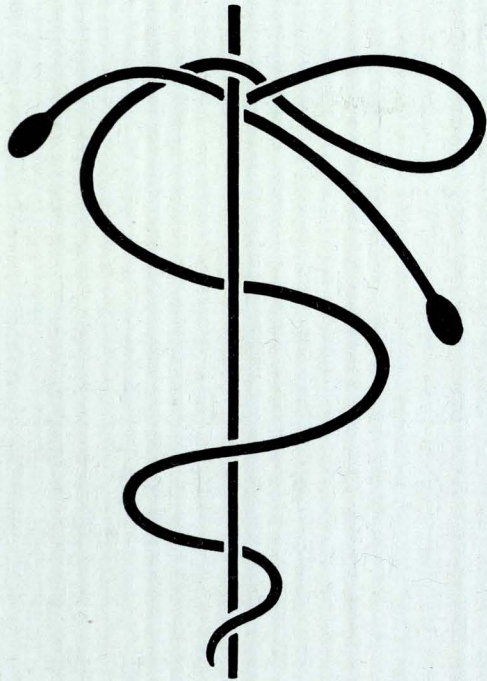

YEARBOOK of the SCHOOL of MEDICINE

PUBLISHED BY THE MEDICAL STUDENTS' SOCIETY

ABOUT THE HIPPOCRATIC OATH

For centuries the Hippocratic Oath has been the exemplar of medical ethics and as such determined the professional attitude of generations of physicians. It was formulated in the fourth century B.C. and is generally considered to be the work of the great Hippocrates.

The Hippocratic Oath clearly falls into two parts — the Covenant and the Ethical Code. The oath starts with an invocation. The Divine are invoked to witness the vow to be taken in order to make it more solemn. The covenant establishes between teacher and pupil the closest and most sacred relationship that can be imagined between men. A spiritual kinship is established between them whereby the teacher is regarded as the “spiritual father” of his pupil.

The ethical code deals partly with medical treatment proper and partly with medical ethics in the strict sense of the word. The rules that are set by the oath to be observed in the treatment of diseases merely reflect the Pythagorean view of disease as a musico-mathematical disharmony. Also the section on medical ethics proper can be understood best as adaptations of Pythagorean teaching to the specific task of the physician. It is justice, first of all, that is required from the physician ; in other words whether the physician is an honest man or not. Justice reveals itself in good manners. Then the promise of silence is demanded to establish professional secrecy as a duty, a moral obligation. As a motivation for the fulfillment of the oath, the physician is promised immortal fame for all time among all men.

In brief the Hippocratic Oath is not an obligation enforced upon the physician by any authority but rather one which he accepts of his own free will. It is not a legal engagement but a solemn promise given and safeguarded only by the conscience of him who swears.

Bulletin of the History of Medicine
By LUDWIG EDELSTEIN

EDITOR

Haroutune Babigian

ARTIST

Edgar Sarrafian

Assistant : Garbis Eknoyan

REWRITE EDITOR

Raja N. Khuri

ASSISTANT EDITORS

Raja K. Khuri

Suhayl Saleh

BUSINESS MANAGER

George Bridi, Munir Nassar

Assistant : Hrair Gulesserian

PHOTOGRAPHY EDITOR

Haroutune Babigian

Assistant : Naim K. Attallah

CIRCULATION MANAGER

Raif Jabir

TECHNICAL ASSISTANCE OF

Photographer : Souren Patatian

Jacket Design : Massis

Printers and Engravers : Bouheiry Bros. (Dar Al-Ahad)

Pictures introducing sections and classes by Haroutune Babigian

MEDICAL STUDENT'S SOCIETY
AMERICAN UNIVERSITY OF BEIRUT
BEIRUT, LEBANON



May 28, 1959

Caduceus

Dear friend:

I am a student approaching the end of my formal training in the practice of the Art of Aesculaepius. Outwardly, they call it the end of the days of discipleship. But personally I feel like the man who has reached a cross-road, who before continuing along his path, stops for a while to look back at the road he has been travelling for a long time.

Behind me there stretches a Quarter of a Century. As I scan my trodden path, it looks so hazy now that I may say that the greater part of it has been banished even from my memory.

I want to take you back with me to examine the slowly grinding process of my making. But as my distant past is no more and cannot be recaptured, I am going to concentrate on my more recent past, namely the last five years which were spent in medical training. In this book I am going to recapture for you my recent medical past by showing you glimpses of others now going through the same stages which I have passed through. Look well! Look well, at those faces and compare, for you should reckon that when I started I was young and inexperienced but after the five years have passed young I am no more.

After our long journey into the past, I pause for a moment of reflection before I begin to scan the other Long Road that stretches ahead. The road behind, even though hazy, is a familiar path that I have once travelled and now with the help of others it has become more vivid. But the road ahead is full of uncertainty and new challenge.

The road behind was long but it has brought me to a new starting point. The road ahead may promise to be longer still and more varied for it will initiate me into the School of Life.

Yours sincerely,

The Student of Medicine

The Student of Medicine

OUR MEDICAL SCHOOL

“We live in this world when we love it”

R. TAGORE

The heritage of our Medical School is unknown to most of us, we therefore fail to appreciate it. We live in a modern era, practise in an upto-date hospital and take our medical knowledge much for granted. Little are we aware of the great efforts put into developing our standards to their present status.

This is a glimpse at the history of our Medical School and a tribute to the pioneers who made its existence possible. Maybe when we know it better, we will love it more.

Reverend C. V. A. VAN DYCK - M. D., L. L. D.,
First Professor of the theory and practice of
Medicine in Beirut, translator of the Bible and
author of many scientific books in Arabic 1818-1895.





General view of A.U.B. (see plan for identification)

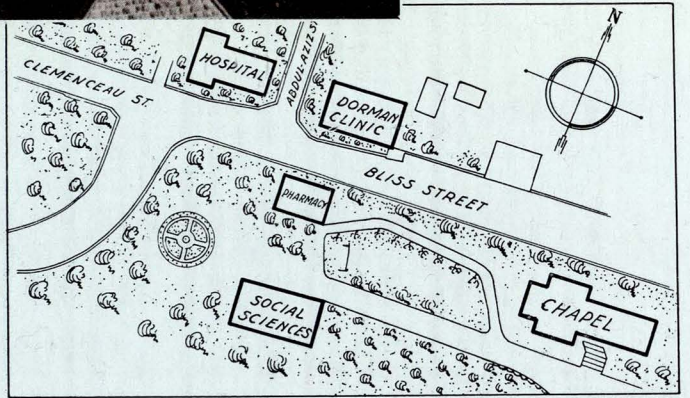

Rue Bliss.



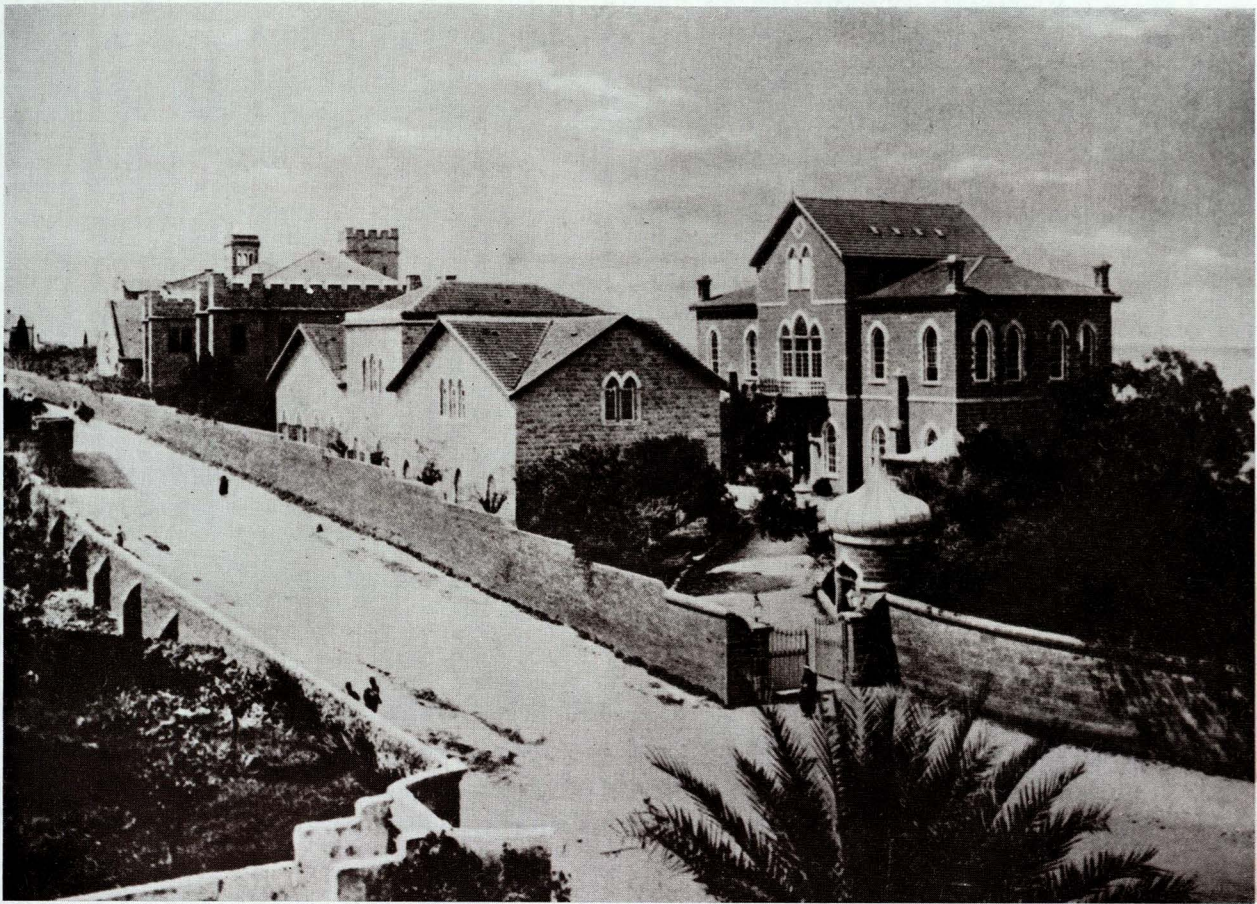

General view of Rue Bliss and the Medical Buildings (*taken from the hospital*).



Medical Gate.



Lt. to Rt. Back Row: William March, Franklin Hoskins, William King Eddy, George Post, Oscar Hardin, Daniel Bliss, William Shedd Nelson, William Jessup, George Doolittle.
Lt. to Rt. Front Row: Henry Jessup, William Bird, Cornelius Van Dyke, William Wordbridge Eddy, Samuel Jessup.



Biochemistry Laboratory.



O. P. D. — E. E. N. T.



Standing for the Alma Mater in the dedication ceremony of the hospital new wing.

Lt. to Rt. Dr. G. Saleeby, dean J. J. McDonald, Mr. Charles Helou, late President S. B. L. Penrose Jr, Dr. H. Chaghlassian.



President Penrose's address at the dedication ceremony.



Operating room 1897



President Bliss (2nd from left, sitting) with faculty members and officials of Turkish Government.



Bal masqué in West Hall auditorium.

First year medical students and staff c. 1931.



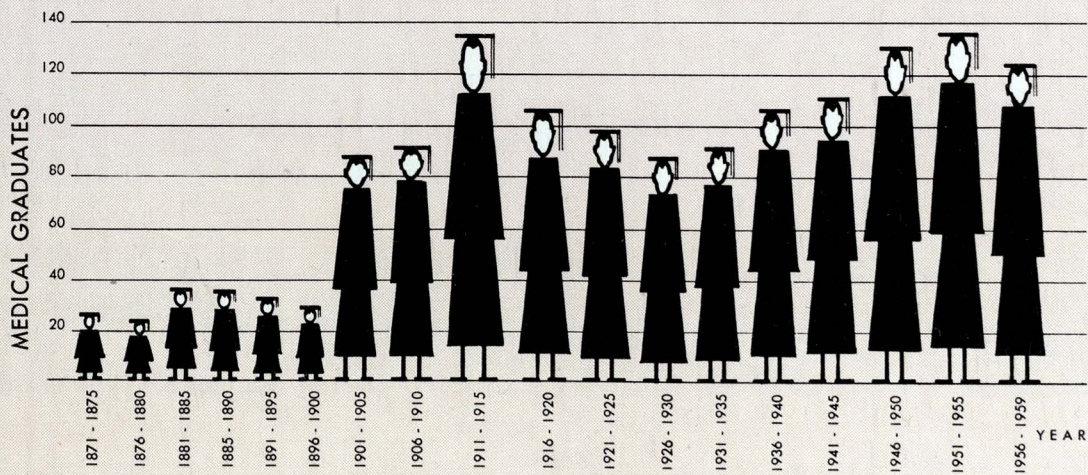
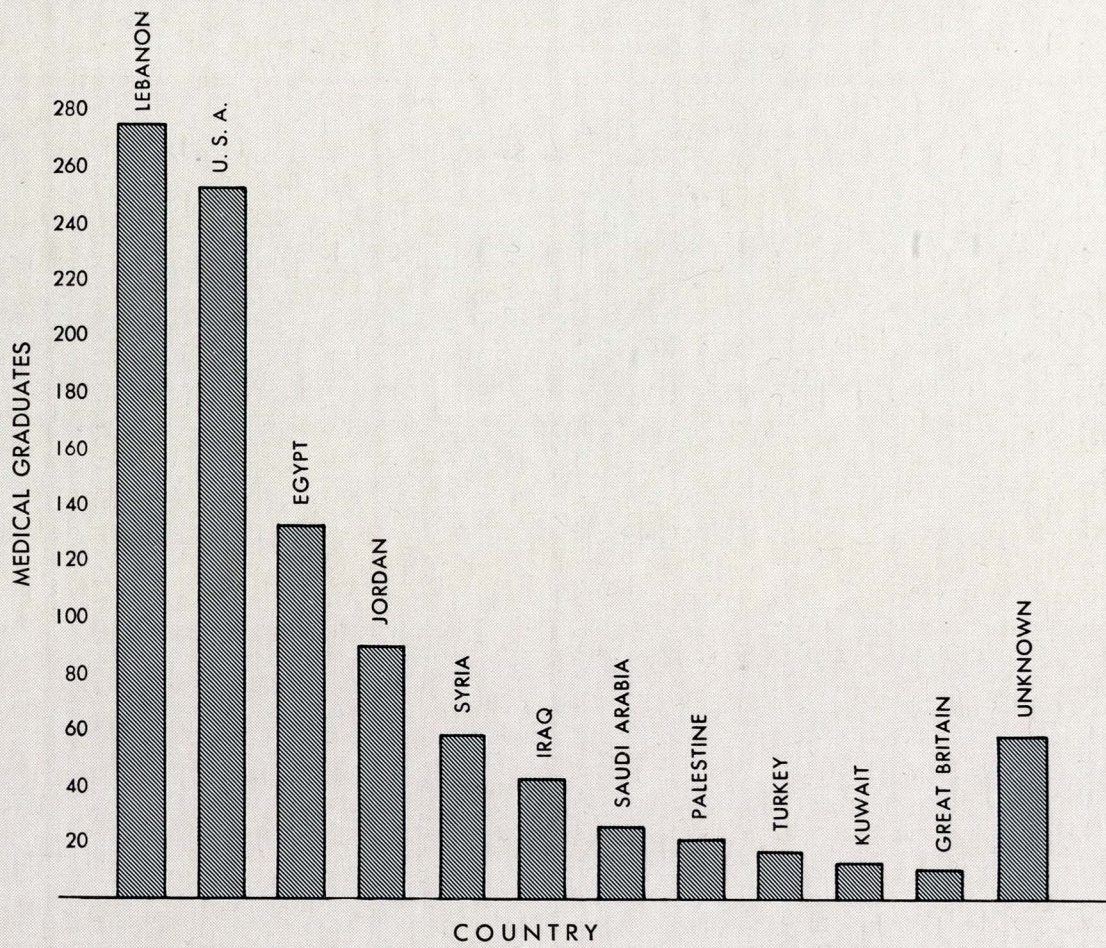

As we approach the end of another school year, we pause to recognize those of you who have completed your course at AUB and are entering upon graduate study or upon the practice of medicine. The years you have spent at the University have given you understanding and technical skill to become a successful professional man. We are now your Alma Mater and you are our alumnus. While you, graduates, will be gone from our campus, we hope you will be closely bound to us wherever you may go.

While at AUB, you have learned those qualities of mind and character which will enable you to serve mankind faithfully. Your profession calls for an unusual devotion to duty without reference to your own comfort and without regard for any factor except human need. "Service above self" is your responsibility. Toward helping you to attain these great ideals, AUB has devoted its efforts; and your success is our success.

We hope for each of you a successful career of service, as true sons and daughters of AUB.

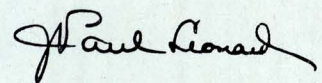

J. PAUL LEONARD
President



J. PAUL LEONARD
President

The medical students and the medical graduates of the American University of Beirut have continued to play an important role in raising our academic standards. Today many graduates are well known in international medical circles. This has helped the medical school in becoming an institutional member of the Association of American Medical Colleges, and in the installation of a Chapter of the Honor Medical Society Alpha Omega Alpha in Beirut.

Your training prepares you to face each new challenge confirmed in the knowledge that you are mentally and technically equipped to accept that challenge. As medicine continues to explore expanding horizons may you have the courage to forge ahead and use effectively the newer medical knowledge. However, always bear in mind that the key to success depends not alone upon leadership but the spirit of students who work together.

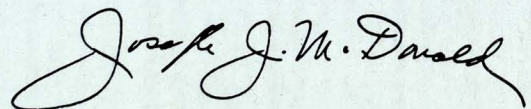
A handwritten signature in cursive script, reading "Joseph J. McDonald". The signature is written in dark ink and is positioned above the printed name and title.

JOSEPH J. McDONALD, M. D.

Dean of the Faculty of Medical Sciences



JOSEPH J. McDONALD — M.D. and M.S., Northwestern University, D. Med. Sc., Columbia University ;
Professor of Surgery

“ That they may preserve life ”

FACULTY



PRECLINICAL

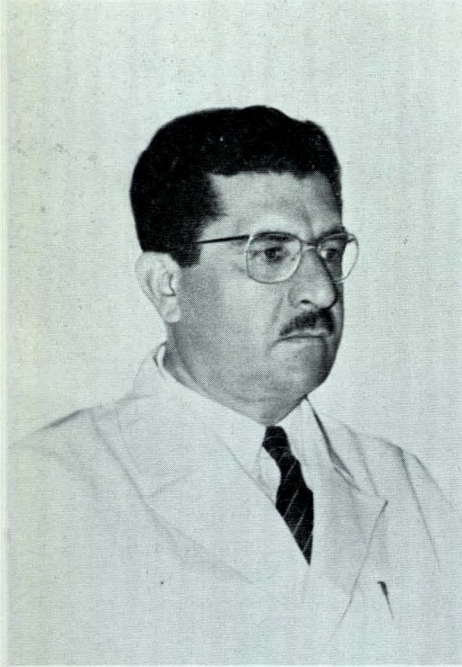

AFIF H. MUFARRIJ - M.D.-A.U.B.;
Assistant Clinical Professor of
Anatomy.

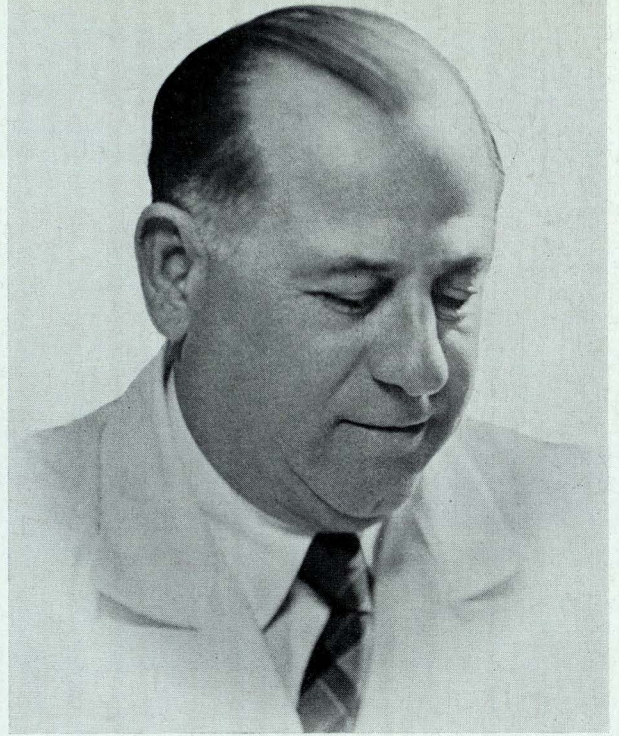

MUSA K. GHANTUS - M.D. - A.U.B.; Professor
of Anatomy.

WILLIAM M. SHANKLIN - Ph. D. - Yale Univer-
sity, D. Sc. - Bridgewater College; Professor of
Histology and Neuroanatomy.



MARIETTA ISSIDORIDES - Ph.D.-
State University of Iowa; Assis-
tant Professor in Histology and
Neuroanatomy (part time).





JOHN H. SCHNEIDER - Ph. D.
University of Wisconsin; Assistant
Professor of Biochemistry.



STANLEY E. KERR - Ph. D. - University of Penn-
sylvania; Professor of Biochemistry.



AVEDIS KHATCHADOURIAN -
M. D. - A. U. B.; Assistant Pro-
fessor of Biochemistry.

HENRY S. BADEER - M. D. - A. U. B.; Associate
Professor of Physiology.

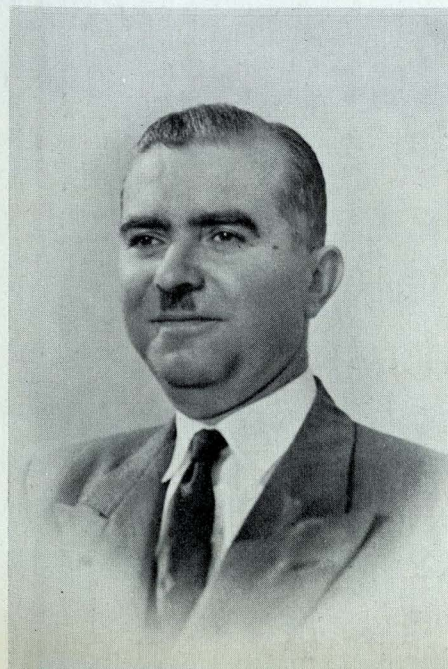

KAMALT. DAOUD - M.D.-A.U.B.;
Instructor in Physiology and
Tropical Health (part time).





GEORGE A. FAWAZ - M. S. - A. U. B. ; Ph. D. - University of Graz, M.D. - University of Heidelberg; Professor of Pharmacology.



MUNIR A. KAN'AN - M.D.-A.U.B.; Associate Clinical Professor of Pharmacology.

PHILIP F. SAHYOUN - M.D. - A.U.B.; Professor of Pathology.

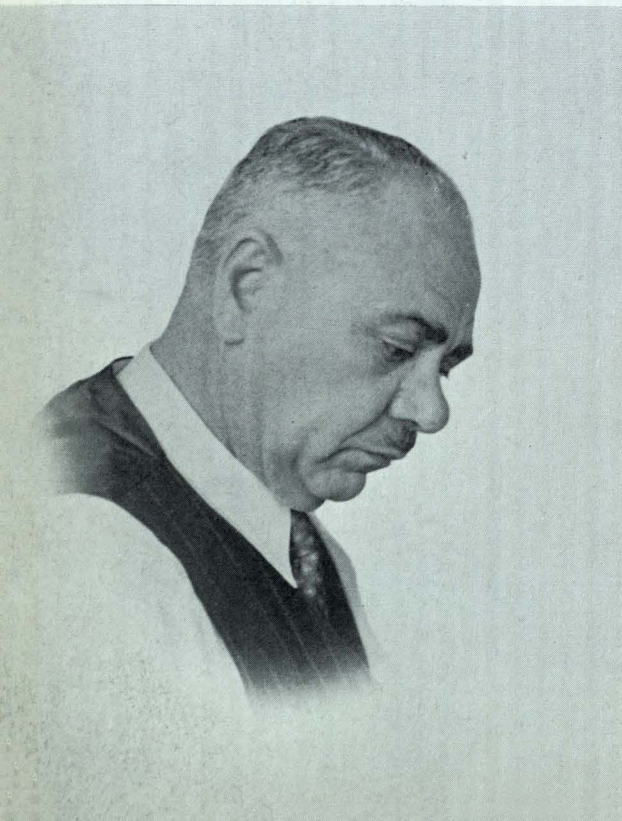

NIMR A. TUKAN - M.D. - A.U.B.; Assistant Professor of Pathology.



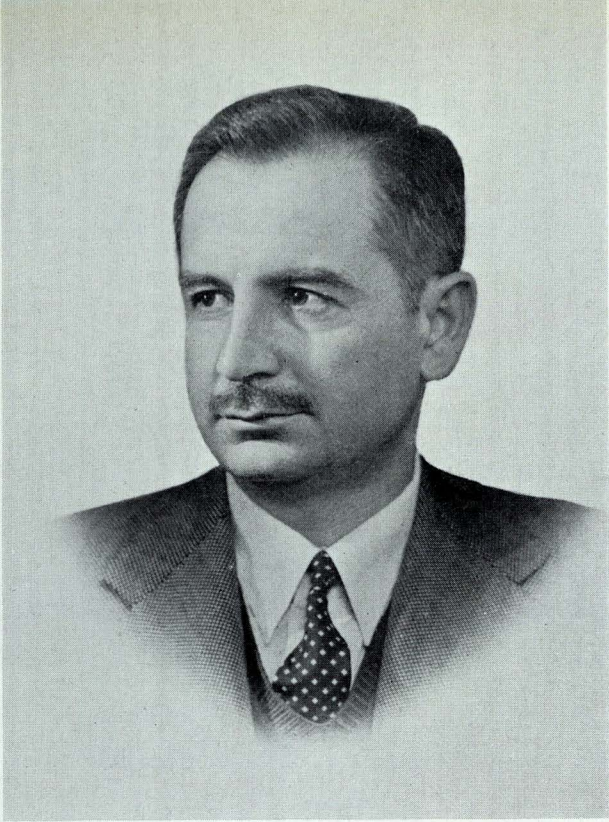

GARABED A. GARABEDIAN - M. S. - A. U. B. ;
Ph. D. - University of Minnesota ; Associate
Professor of Bacteriology & Virology.

CALVIN W. SCHWABE - M. S. - University of
Hawaii, D. V. M. Alabama Polytechnic Institute,
M. P. H., Sc. D., Harvard University; Associate
Professor of Tropical Health



HENRY A. AZAR - M. D. - A. U. B. ;
Assistant Professor of Pathology.



LEWIS A. SCHINAZI - M. A. Ph.
D. - University of California Los
Angeles ; Assistant Professor of
Parasitology & Tropical Health.



Mrs. EUPHRONIA MEYMARIAN
B. A. - A. U. B. ; Assistant Instructor
in Tropical Health.



DEPARTMENT OF MEDICINE



CALVIN H. PLIMPTON - M.D. & M.S. - Harvard Medical School, D. Med. Sc. - Columbia University; Professor of Medicine.

HOYSEP A. YENIKOMSHIAN - M. D. - A. U. B., D. T. M. & H. - England, M. R. C. P. London; Clinical Professor of Internal Medicine.

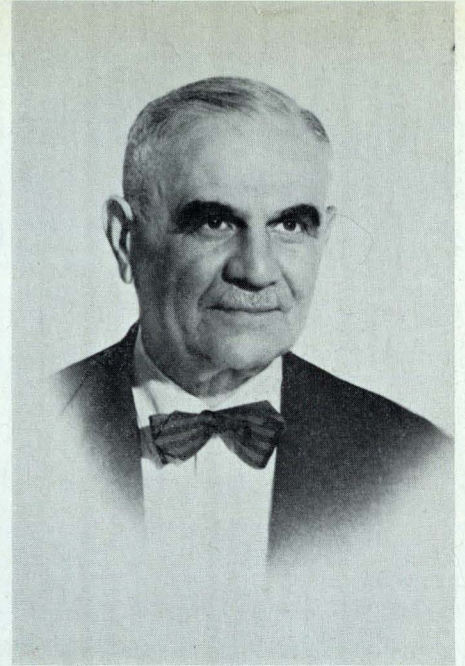

GEORGE B. KHAYAT - M. D. - A. U. B.; Clinical Professor of Internal Medicine.



Resident Staff



Najib Shehadeh M. D.



Farid Fuleihan M. D.



HRANT T. CHAGLISSIAN-M.D.-
A. U. B. ; Professor of Dermato-
logy & Syphilology.



SHAFIK N. HADDAD - M. D. -
A. U. B., D. T. M. - Liverpool ;
M.R.C.P. - Edin.; Associate Cli-
nical Professor of Internal Me-
dicine.



MUNIB J. SHAHID -M.D.-A.U.B.;
Associate Clinical Professor of
Internal Medicine.



RIYAD A. TABBARA -M.D.-A.U.B.;
Associate Professor of Internal
Medicine.



Ropovt Chorbajian M. D.



Sami Kaid Bey M. D.

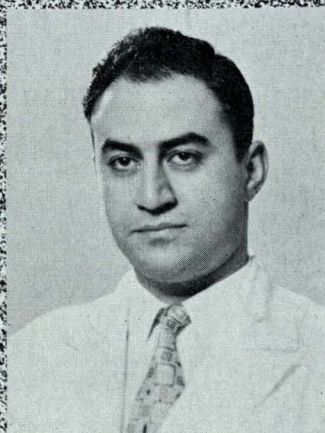

Nebil W. Mukhaybir M. D.



FUAD A. SABRA - M.D. - A.U.B.;
Associate Prof. of Neurology.

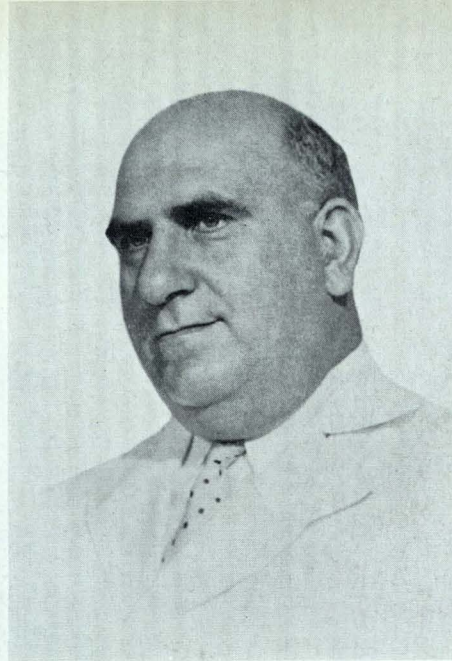

GREGOIRE A. DRAGATSI - M. D. - A. U. B.
D. T. M. & H. - England; Associate Clinical,
Professor of Internal Medicine.



EDMUND I. SHWAYRI - M. D. -
A.U.B.; Assistant Professor of
Internal Medicine.



NAJIB I. ABU-HAIDAR - M. D. -
A.U.B.; Assistant Professor in
Internal Medicine.



Jawdat Khalaf M. D.



Nadra Haddad M. D.



Hind Shuman M. D.

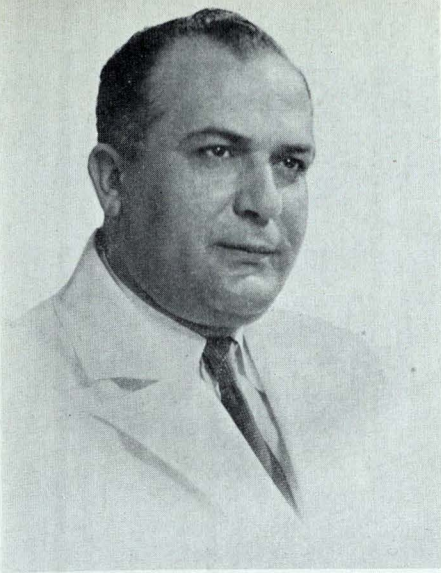

JOSEPH E. AZAR - M.D. - A.U.B.;
D.T.M. & H. - England; Assistant
Professor of Communicable
Diseases.

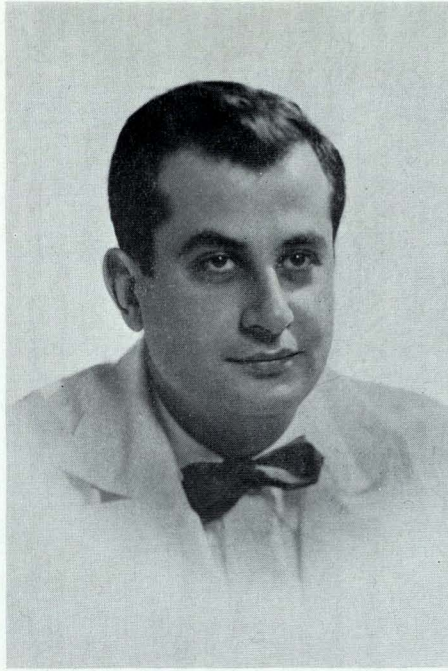

MUNIR H. SHAMMA'A - M. D. -
A. U. B.; Clinical Instructor in
Medicine.



JEAN N. MOACDIÉ-M.D.-A.U.B.;
Clinical Instructor in Internal
Medicine.



GEORGE A. RUBEIZ - M. D. -
A.U.B.; Instructor in Internal
Medicine.

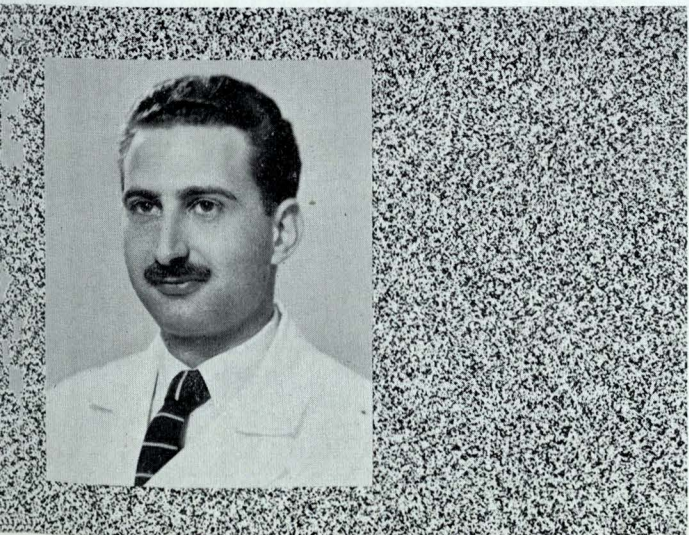

Amin Faris M. D.

CHARLES N. NUCHO - M. D. -
A. U. B. ; Instructor in Internal
Medicine (part time).

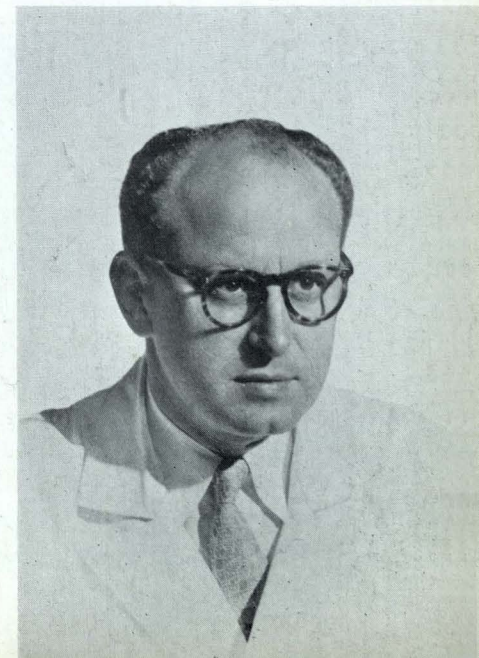

DEPARTMENT OF SURGERY



YERVANT D. JIDEJIAN - M.D. - A.U.B., F.A.C.S.;
Clinical Professor of Surgery.

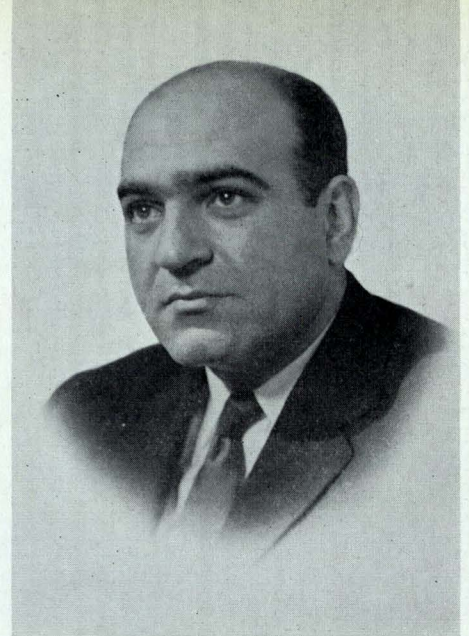

BAHIJ S. AZOURI - M. D.-A.U.B.,
D. Med Sc. - Columbia University;
Assistant Clinical Professor
in Surgery.



AFIF Z. NSOULI - M.D. - A.U.B ;
Assistant Clinical Professor of
Surgery.

Resident Staff

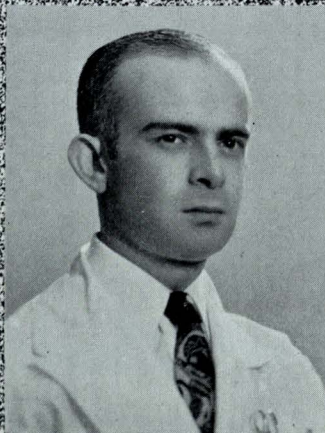

Najdat Pasha M. D.

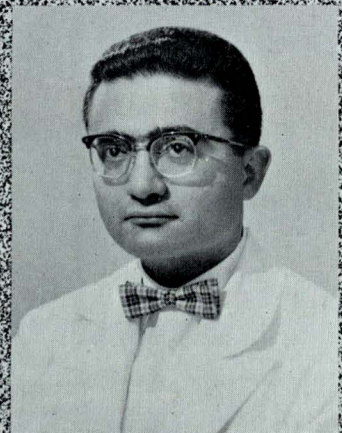

Faiz Suidan M. D.



PHILIP G. ANTYPPIA - M. D. -
A.U.B. ; Assistant Clinical Pro-
fessor of Surgery.



FUAD. S. HADDAD - M. D. -
A. U. B. ; F R C.S. (C); Assistant
Clinical Professor of Surgery.



HAGOP D. YACOUBIAN - M. D. - A. U. B. ;
Clinical Assistant Professor in Surgery, and
part time Instructor in Anatomy.

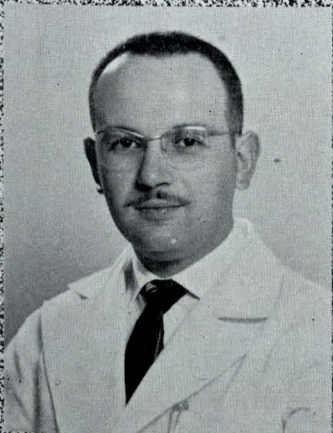

Kamal Hemadi M. D.



Samir Shehadeh M. D.

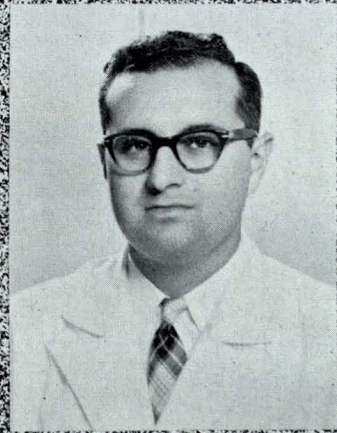

William Audeh M. D.



IBRAHIM K. DAGHIR - M. D. -
A. U. B.; Assistant Professor in
Surgery.



SAMI J. OBEID - M. D. - A.U.B.;
Assistant Professor in Surgery.



Taher Dajani M. D.



Hassan Tabbarah M. D.

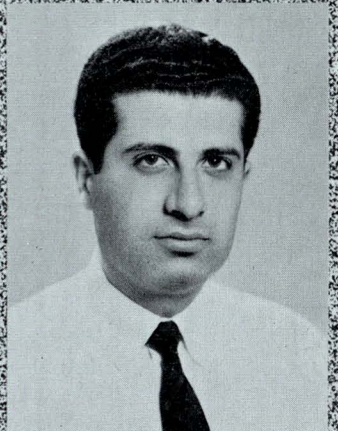

Farid Yagham M. D.



Ramiz Azoury M. D.



Fuad Dagher M. D.



Aram Hanissian M. D.

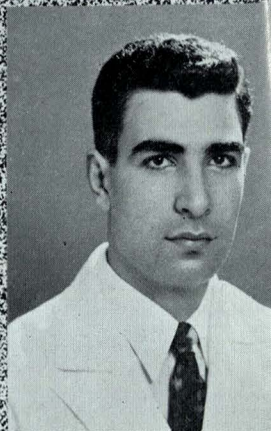

Joseph Siman M. D.



KHATTAR Y. KAN'AN - M. D.,
A. U. B. ; Assistant Hospital
Anesthetist.

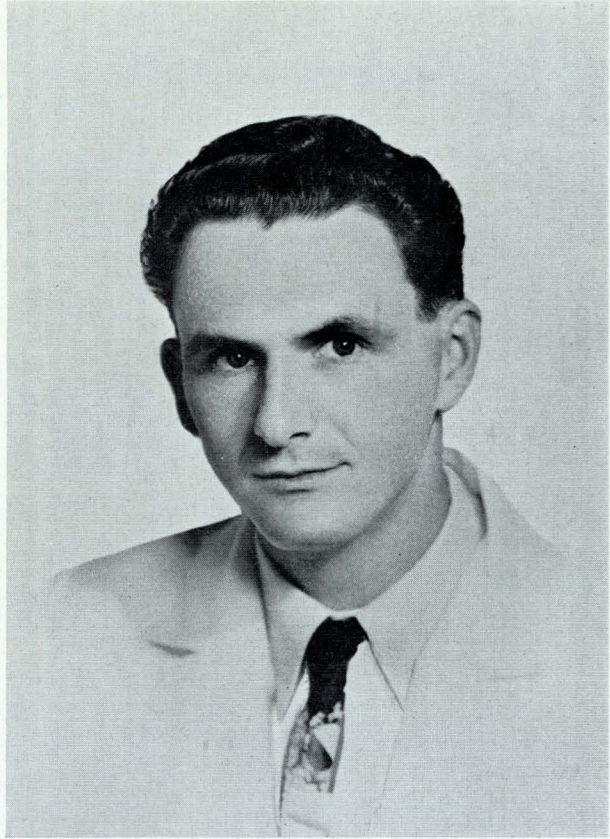

BERNARD J. BRANDSTATER - M. D., B. S. - University of
Adelaide (Australia), F. A. C. A. Graduate School of Med-
ical University of Pennsylvania, D. A., F. F. A. R. C. S.
Royal College of Surgeons of England ; Associate
Professor of Anesthesiology.

MISS RENA B. MYERS - R. N.
Toumey Hospital (So. Carolina);
Lecturer in Anesthesiology.



DEPARTMENT OF ANESTHESIA

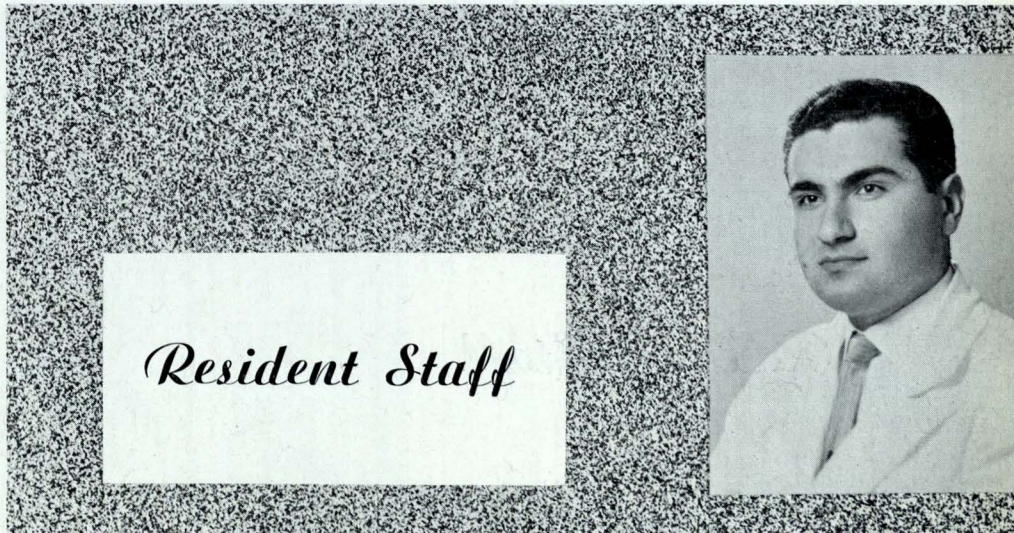

Resident Staff

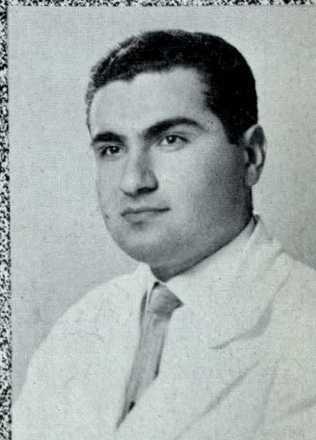

Musa Muallem M. D.

*DEPARTMENT
OF
OBSTETRICS AND GYNECOLOGY*



SUSAN W. WILLIAMSON - M. D. - Cornell Medical School; Professor of Obstetrics and Gynecology.



ADMA E. ABUCHDID - M. D. - A. U. B. ; Associate Clinical Professor of Gynecology and Obstetrics.

Resident Staff

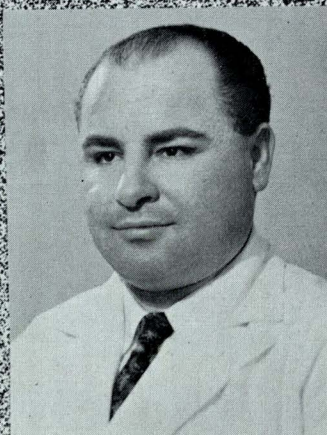

Akil Tutunji M. D.



Salma Kabbani M. D.



IBRAHIM H. MUFARRIJ - M. D. -
A.U.B.; Assistant Professor of
Obstetrics & Gynecology.

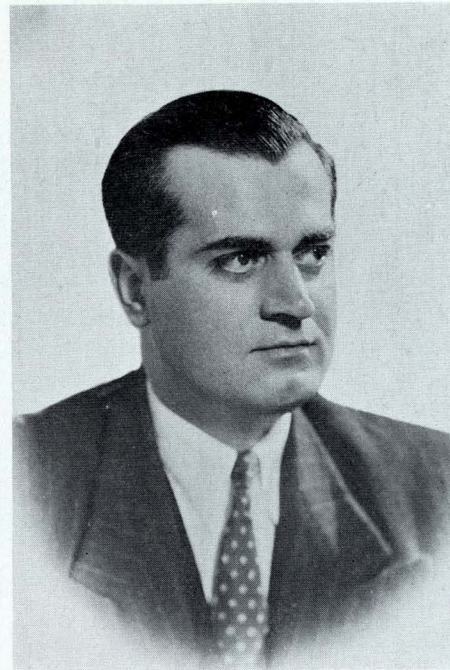

JOHN A. SAHAKIAN - M. D. -
Faculté Française de Médecine
Beirut; Clinical Instructor in
Obstetrics & Gynecology.



Najla H. Na'man M. D.

DEPARTMENT OF PEDIATRICS



HANS U. ZELLWEGER - M. D. - University of Zurich; Professor of Pediatrics.



HASSAN M. IDRIS - M. D. - A. U. B. ; Associate Clinical Professor of Pediatrics.

Resident Staff



Barkev Andonian M. D.

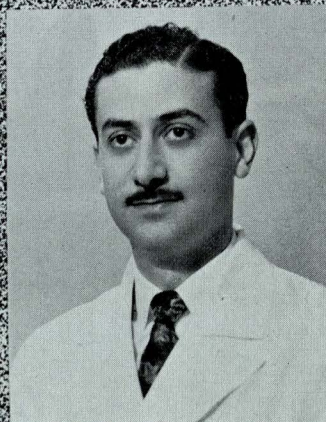

Raja Asfour M. D.

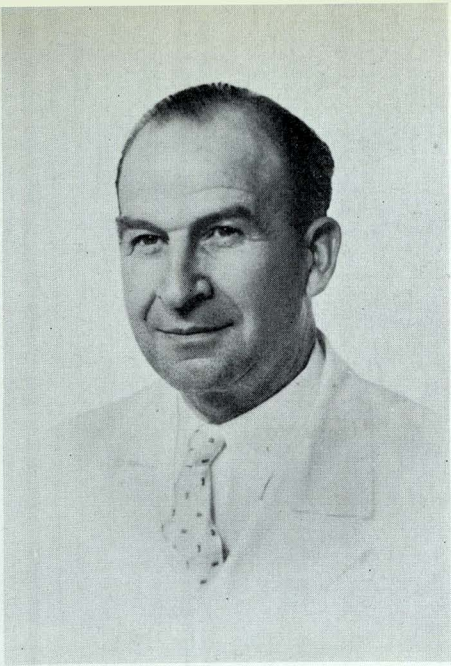

HENRY S. NACHMAN - M. D. -
A.U.B.; Associate Clinical Profes-
sor of Pediatrics.



MARIA Z. SALAM - M.D. - A.U.B.;
Instructor in Pediatrics.

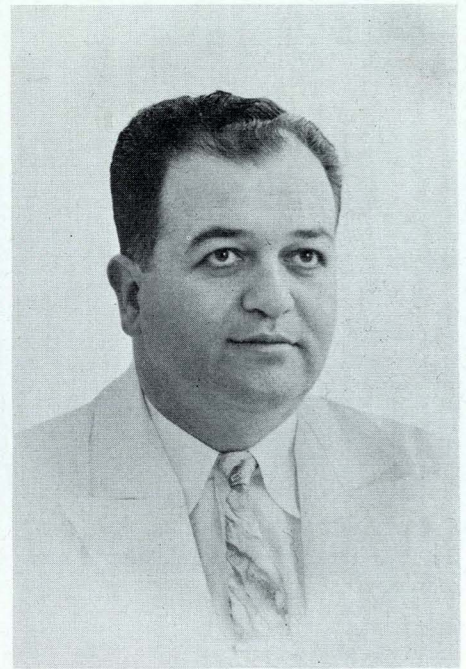

SALIM S. FIRZLI - M.D. - A.U.B. ;
Assistant Professor in Pedia-
trics.

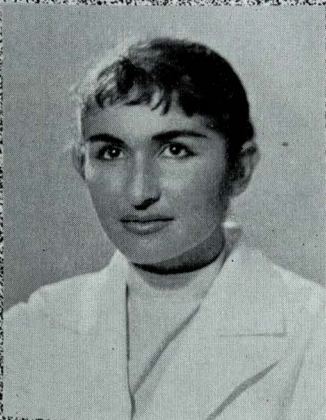

Daad Khoury M. D.



Gloria Bendali M. D.



Alice Abdul Nour M. D.

DEPARTMENT OF E. E. N. T.



ALFRED E. DIAB - M.D. - A. U. B., F. A. C. S.
F. I. C. S.; Professor of Ophthalmology and
Otolaryngology.

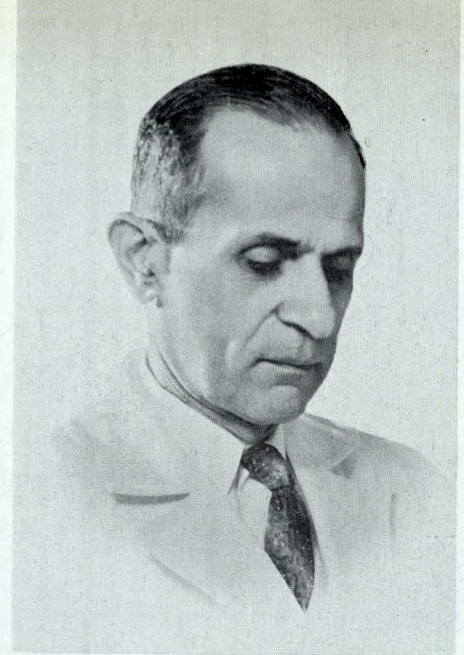

ARAM S. BAGHDASSARIAN -
D.D.S., M.D. - A.U.B.; Associate
Clinical Professor of Ophthal-
mology & Otolaryngology.



CAMILLE S. MATTA - M. D. -
A. U. B.; Assistant Professor in
Ophthalmology and Otolaryn-
gology.

Resident Staff



Yahya Farhat M. D.



Adnan Halasa M. D.

DEPARTMENT OF RADIOLOGY



DIRAN O. MIKAELIAN - M. D. -
A.U.B.; Instructor in Ophthalmology
and Otolaryngology.

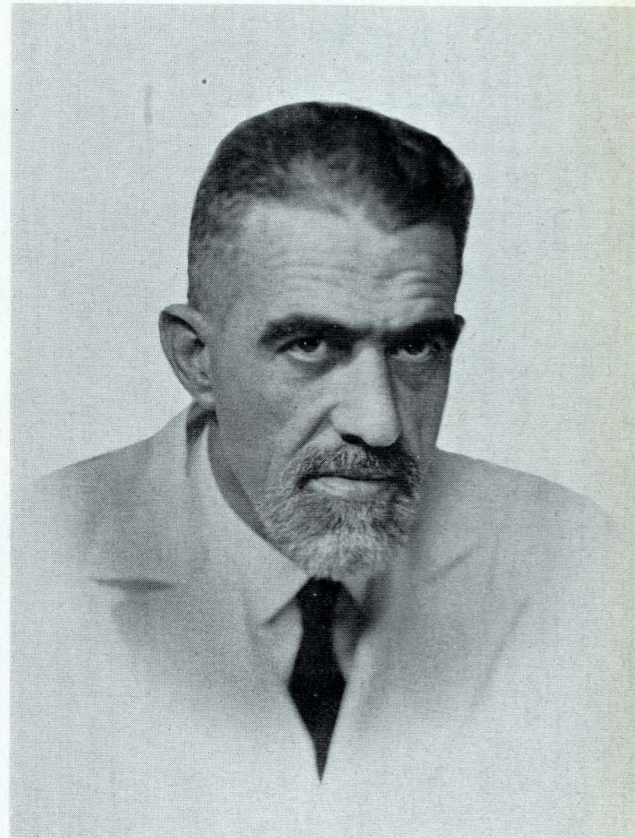

LEONARDO M. GIACCAI - M.D. - University of
Florence; Professor of Roentgenology.

GEORGE W. SALEEBY - M. D. -
A.U.B.; Associate Professor of
Roentgenology.



PHILIP J. ISSA - M. D. - Faculté
Française de Médecine, Beirut;
Instructor in Radiology.

DEPARTMENT OF PSYCHIATRY



ANTRANIG S. MANOUGIAN - M. D. - A. U. B.;
Associate Clinical Professor of Psychiatry.

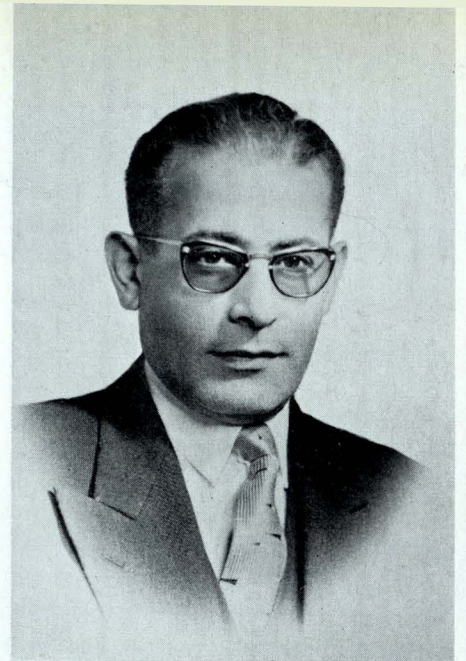

JOHN C. HAYEK - M.D. - A.U.B.;
Instructor in Psychiatry (part
time).

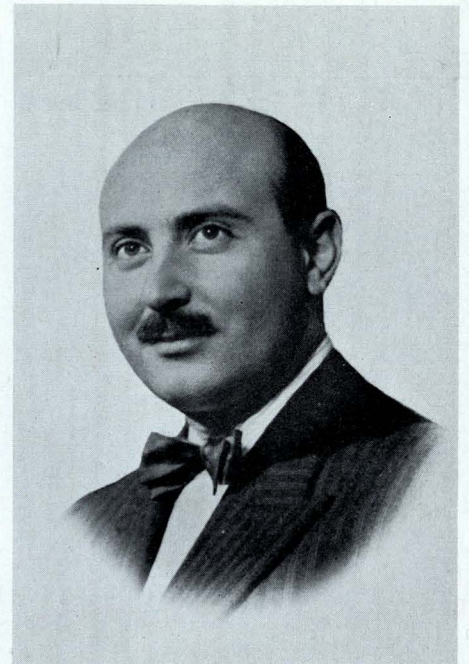

ALA'UD-DIN S. DROOBY - M.D.-
University of Lausanne; Ins-
tructor in Psychiatry (part time).

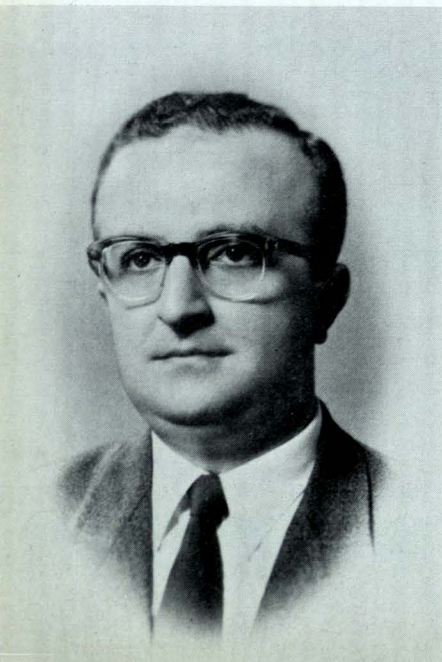

VAHE R. PUZANTIAN - M.D. - A.U.B.
D.P.M. - London; Resident Psychiatrist
L.H.M.N.D.

*DEPARTMENT
OF LABORATORY STUDIES*



GEORGE I. ABU - HAIDAR -
M. A. - A. U. B. ; Instructor in
Biological Chemistry (part time).

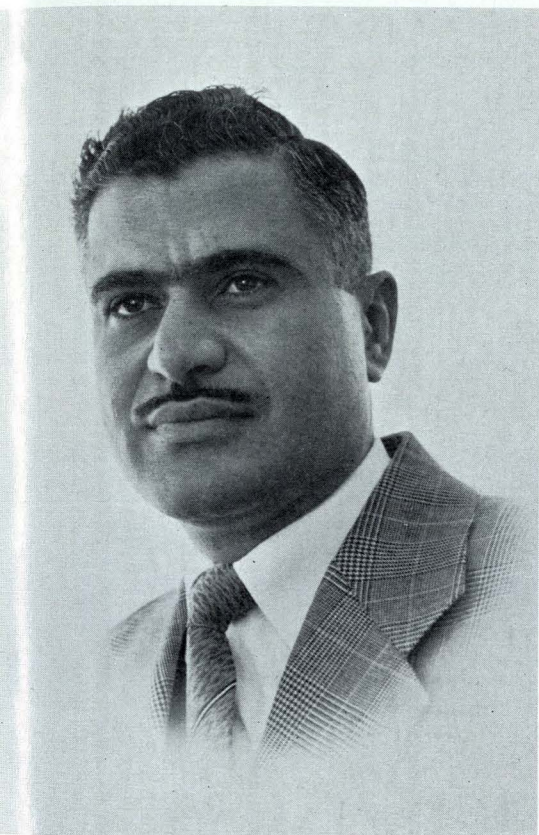

RAIF E. NASSIF - M. D. - A. U. B.; Associate
Professor in Laboratory Studies.



HARLAN L. PAINE JR. - A. B. Brown Uni-
versity; M. H. A. Northwestern Univer-
sity. Hospital Administrator.

DEPARTMENT OF PUBLIC HEALTH



HOWARD W. MITCHELL - M.D., M. P. H.-
Michigan; Associate Professor of Public Health.

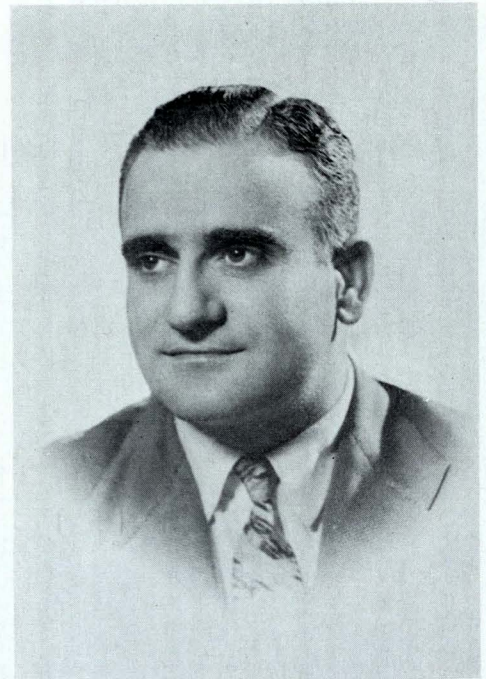

GABRIEL E. RIFKA - M.D. - A.U.B.;
D.T.M. & H. - London; Assistant
Professor in Public Health
Practice.

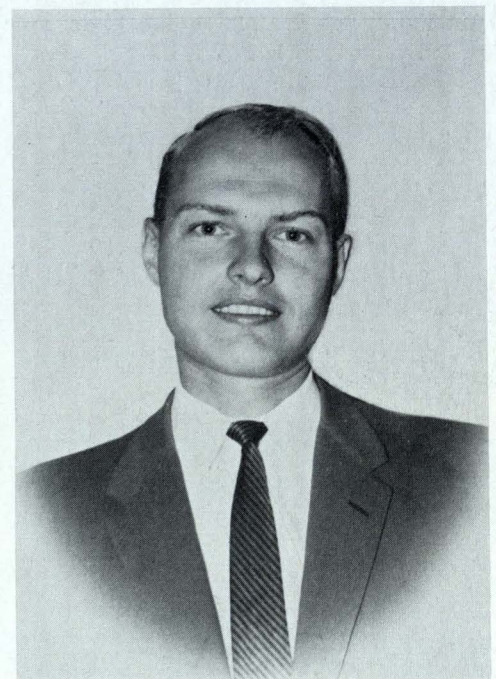

LAVAND SYVERSON - B.A. - Wheaton college,
Illinois, M. S. - General Administration, M. S. -
Hospital Administration, Columbia University.
O. P. D. Administrator.

THE MEDICAL LIBRARY



Mrs. A. K. Sarrafian
Librarian.



Circulation Desk.



Staff — Lt. to Rt. — A. Muruwah, G. Eknoyan, Mrs. A. K. Sarrafian, Miss. Sabounjian, A. Kana'an, G. Ghosn.



Entrance.



Study Room.

THE RESIDENT STAFF ORGANIZATION

The committee that was elected this year was elected at around the middle of the scholastic year because the previous committee did not call for a meeting before that time. The Resident Staff Organization met on a few occasions, the first time was to choose the adviser for this year. Dr. Chaglassian won with a high majority and he consented to serve as Adviser. During the other meetings the project of starting a photography club for the resident staff was approved, suggestions for improving the quality and variety of food in the cafeteria were made, and ideas as how to ameliorate the living quarters of the residents were given. The lady doctors, whose number this year hit the ceiling complained that they do not have any of the necessities such as a telephone, a refrigerator and running hot water. All these problems were taken up by the members of the committee and discussed with the responsible persons. Miss Sara Der Bedrossian, the Dietitian, promised to bring in some more variety of food and she started by getting Kashkawan Cheese in the mornings once or twice a week. Mr. Paine, the Hospital Administrator, promised to see that the requests of our lady doctors be granted by the beginning of the coming scholastic year. As far as the Out-Patient Department is concerned, the electric power supply is being increased and the bathrooms remodelled. The formation of the photography club was delayed to the coming year because the space in the old dentistry building that was assigned for a dark room was occupied by some visiting male nurses. We hope that the visiting nurses next year would be only females and hence leave our beloved dark room vacant.

As far as social activities are concerned, we cannot say that a lot has been done. We had one dancing party held in our lounge. In spite of the fact that it was announced that all the drinks would be on the house, only seven couples showed up. Most of the residents who did not come claimed that they did not know any girl so as to invite her and poor Ramez Azoury could not supply more than two girls that night.

I hope that the residents will meet early this coming year and that they will have a fruitful time, and have it abundantly. I also like to ask them to keep up the spirit of cooperation between the different departments such as we had this year and thus promote a better understanding of each other and a better care for the patients.

FAYEZ SUIDAN, M. D.
President Resident Staff Organization

SURGERY.

- Najdat PASHA : Chief resident in surgery, Cleveland Metropolitan General Hosp.
Faiz SUIDAN : To specialize in Obs. Gyn. in Chicago Lying-in Hospital.
Kamal HEMADY : Senior Resident, A.U.H.
Samir SHEHADEH : Senior Resident, A.U.H.
William AUDEH : To specialize in surgery in U.S.A.
Taher DAJANI : Resident, A. U. H.
Hasan TABBARAH : Resident A.U.H.
Farid YAGHNAM : Resident A.U.H.
Fuad DAGHER : Senior Assistant Resident, A.U.H.
Ramez AZOURY : Senior Assistant Resident, A.U.H.
Joseph SIMAN : Senior Assistant Resident, A.U.H.

MEDICINE.

- Najib SHEHADEH : To specialize in Dermatology in the University of Pennsylvania Hospital, Philadelphia.
Ropovt CHORBAJIAN : Resident A.U.H.
Farid FULEIHAN : Resident A.U.H.
Sami KAID BEY : Fellow in Cardiology, A.U.H.
Nabil MUKHAIBER : To work in the Infirmary, A.U.B.
Amin FARIS : Senior Assistant Resident, A.U.H.
Nadra HADDAD : To specialize in Pediatrics in Iowa City Hospital, Iowa University.
Jawdat KHALAF : To continue in Baylor Hospital, Dallas, Texas.
Hind SHUMAN : To specialize in Radiology in Francis Delafield Hospital, Columbia University.

OBSTETRICS AND GYNECOLOGY.

- Akil TUTUNJI : Private practice, Amman, Jordan.
Salma KABBANI : Resident A.U.H.
Najla NA'MAN : Senior Assistant Resident, A.U.H.

E. E. N. T.

- Yahya FARHAT : Resident A.U.H.
Adnan HALASA : Resident A.U.H.

PEDIATRICS.

- Barkev ANDONIAN : Assistant Instructor in Pediatrics, A.U.H.
Raja ASFOUR : Resident A.U.H.
Gloria BENDALI : To stay in Pediatrics till December.
Alice ABDUL NOUR : To stay in Pediatrics till December.

ANESTHESIOLOGY.

- Musa MUALLEM : Uncertain.

*“Man is born child, his power is the
power of growth.”*

R. TAGORE

STUDENTS



CLASS EDITOR :

RAJA N. KHURI.

“The service of the fruit is precious, the service of the flower is sweet, but let my service be the service of the leaves in its shade of humble devotion.”

R. TAGORE

CLASS OF 1959





FARUK ABUL-DHAHAB

Beirut, Lebanon.

Outlook reporter, 1951-1953.

Manager, Student Cooperative Society, A.U.B. 1952-1955.

Alpha Omega Alpha Honor Medical Society, A.U.B. Chapter,
Secretary-Treasurer 1958-1959.

Charter Member 1958-

Chairman, M.S.S. Committee for International Cooperation,
1958-59.

M.S.S. Anniversary Show, 1958.

Appointment for 1959-1960: First Year Resident, Henry Phipps
Psychiatric Clinic, The Johns Hopkins Hospital, Baltimore,
Maryland; U.S.A.

ADIL BIRBARI

Ziguinchor, Senegal.

Appointment for 1959-1960: First Year Resident, Department
of Internal Medicine, A.U.H.

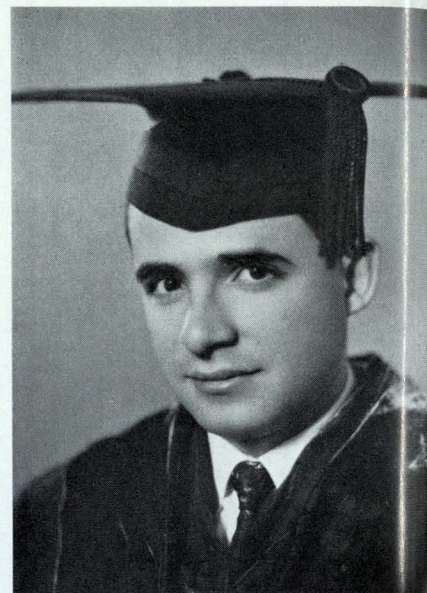

MAURICE BARUDY

Souk-el Gharb, Lebanon.

A.U.B. Champion, Archery, 1954.

A.U.B. Champion, Rifle Shooting, 1958 (Record Holder).

Appointment for 1959-1960: to work for Tapline Company.

RASHID FULAYFIL

Moharraq, Bahrain.

Appointment for 1959-1960: Residency training Dallas County
Hosp. district, Woodlawn Hosp. Dallas 35, Texas.



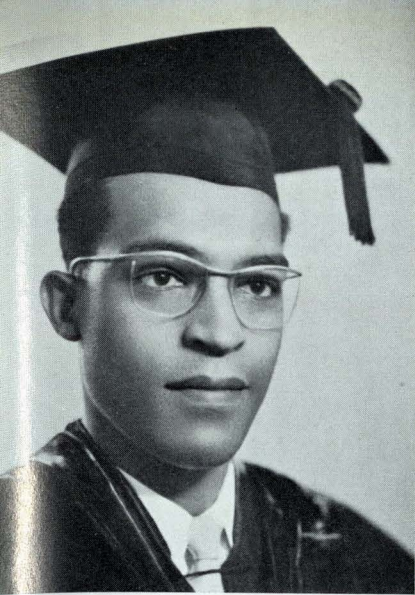

AKLOG HAPTE-MICHAEL

Harar, Ethiopia.

Treasurer, Ethiopian Student Association, 1952-55.

Appointment for 1959-1960: To work in a Government Hospital in Ethiopia.

RAIF JABIR

Ain Ksour, Lebanon.

Caduceus, Circulation Manager 1957-1959.

M.S.S. Cabinet Member 1956-57.

Appointment for 1959-60: First Year Resident, Department of Surgery, A.U.H.

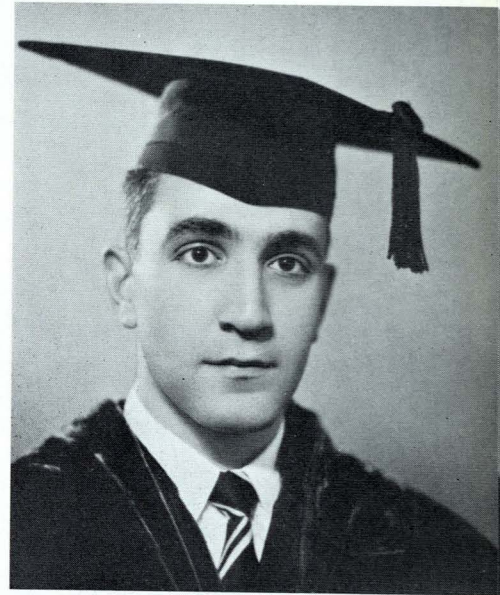

FAWZI ILIYYA

Beirut, Lebanon.

Appointment for 1959-1960: First Year Resident, Department of Obstetrics & Gynecology, A.U.H.

ILYAS LUBBAT

Jerusalem, Jordan.

Medical School Football Team 1954-59.

M.S.S. Cabinet, Member 1956-57.

Appointment for 1959-60: First Year Resident, Department of Internal Medicine, A.U.H.

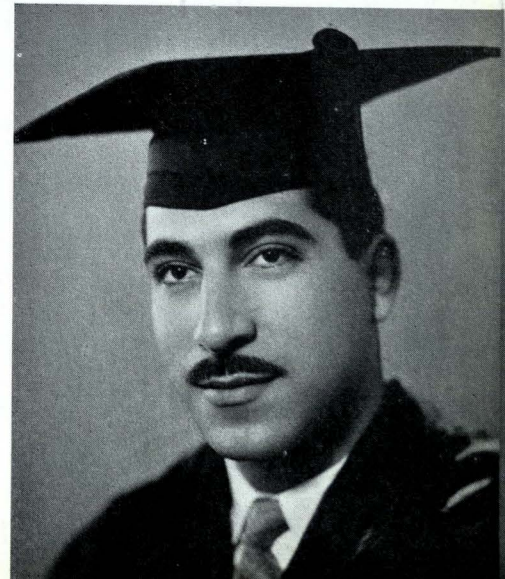



ISKANDAR JIHA

Beirut, Lebanon.

M.S.S. Anniversary Committee 1958-1959.

Caduceus, Class reporter, 1959.

Alpha Omega Alpha Honor Medical Society, A.U.B. Chapter, Member, 1958-

Appointment for 1959-1960: First Year Resident, Department of Surgery, A.U.H.

RIYAD KHALIFAH

Ain Anoub, Lebanon.

Appointment for 1959-60: First Year Resident, Department of Internal Medicine, A.U.H.

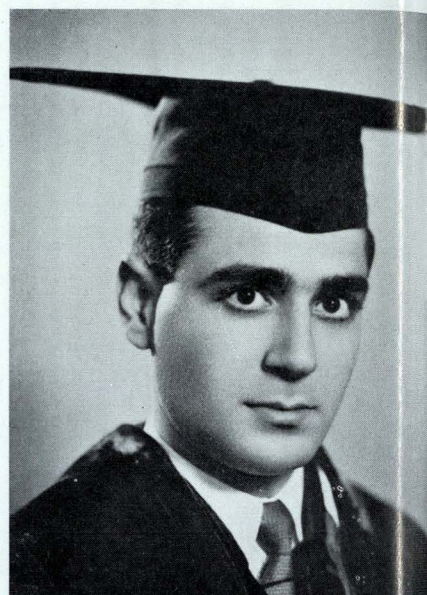

RAJA KHURI

Beirut, Lebanon.

Club Commissioner, Lebanese Boy Scout Association, 1954-59.

Penrose Award 1955.

Caduceus Class Editor, 1957-59.

Caduceus Assistant Editor, 1958.

M.S.S., President 1958-59.

Alpha Omega Alpha Honor Medical Society, A.U.B. Chapter

Vice President 1958-59

Charter Member 1958-

Appointment for 1959-60: First Year Resident, Department of Internal Medicine, A.U.H.

WIDAD KIDANE-MARIAM

Jerusalem, Jordan.

Ethiopian Students Organization, Secretary, 1953-55.

M.S.S. Cabinet, Class Representative 1954-55.

René Farah Scholarship Committee, Secretary, 1957-59.

To specialize later in Cardiology in Britain or U.S.A.





SAMIR JAHSHAN

Jerusalem, Jordan.

Outlook Reporter 1953-54.

Pole Vault, A.U.B. Champion 1953-58.

Medical School Football Team, Captain, 1956-58.

Appointment for 1959-60: First Year Resident in Otorhinlaryngology, Strong Memorial Hospital, Rochester, N.Y., U.S.A.

ARA MADONIAN

Jerusalem, Jordan.

Appointment for 1959-60: Straight Surgical Intern, State University of New York, Upstate Medical Center, Syracuse, N. Y. ; U.S.A.



SAMI NASSAR

Beirut, Lebanon.

Medical School Football Team, 1954-58.

Appointment for 1959-60: First Year Resident, Department of Surgery, A.U.H.

MUNIR NASSAR

Beirut, Lebanon.

Caduceus, Business Manager, 1956-59.

M.S.S. Bulletin, Business Manager. 1958-59.

Appointment for 1959-60: First Year Resident, Internal Medicine, Methodist Hospital, Baylor University, Texas Medical Center, Houston, Texas, U.S.A.





ANWAR RADWAN

Beirut, Lebanon.

A.U.B. Fencing Team.

Appointment for 1959-60: Intern, Fairview Park Hospital,
Cleveland, Ohio; U.S.A.

TATYANA RODENKO

Jafa, Palestine.

A.U.B. Runner-up, Tennis, Women's, 1953-55.

W.S.O., Medical School Representative, 1955-56.

Women's Hostel Council, Member, 1957-58.

To have training in Pediatrics in the future.



MICHEL RUBAYZ

Beirut, Lebanon.

Appointment for 1959-60: First Year Resident, Department of
Surgery, A.U.H.

NIKULA SAB

Beirut, Lebanon.

Caduceus, Class Editor, 1956-58.

Caduceus, Assistant Editor, 1958.

Outlook Editor, October 1958-February 1959.

Alpha Omega Alpha Honor Medical Society, A.U.B. Chapter,
Member, 1958—

Appointment for 1959-60: First Year Resident, Department of
Internal Medicine, A.U.H.

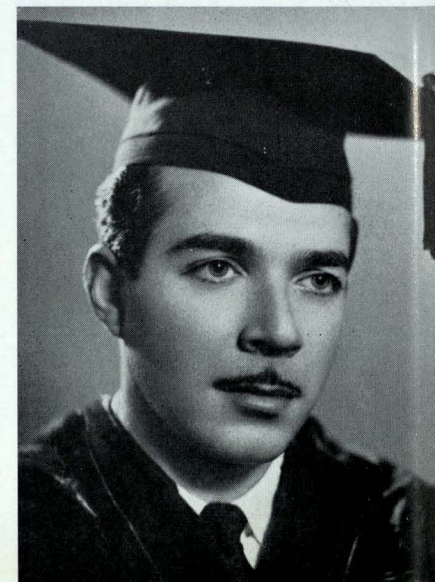



ALEXANDER SADIK
Bsharreh, Lebanon.

Appointment for 1959-60; First Year Resident, Department of Surgery, A.U.H.

ATIF SA'D
Gharifeh, Lebanon.

Appointment for 1959-60; First Year Resident in Internal Medicine, Huron Road Hospital, Cleveland, Ohio; U.S.A.

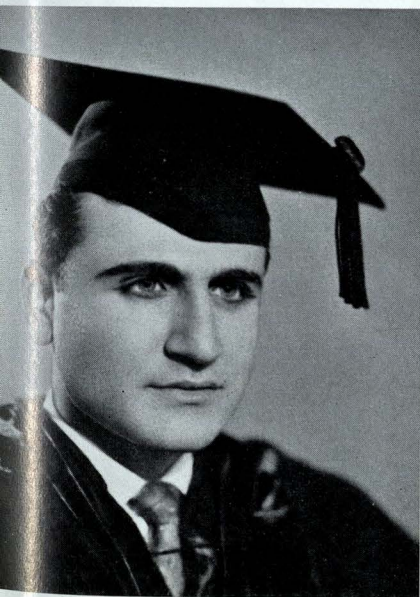
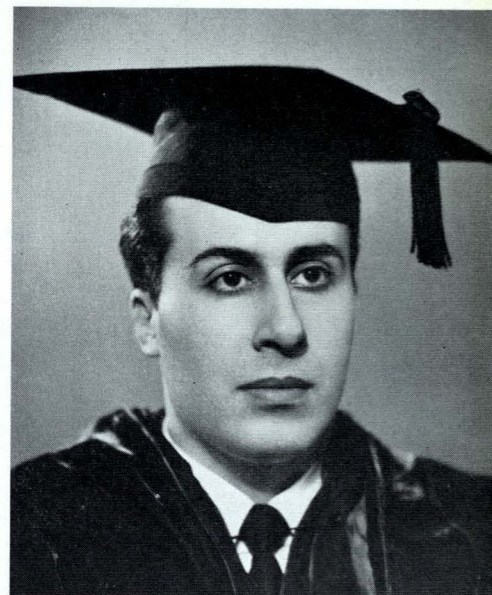

ANTOUN SALIM
Btarram, Lebanon.

Appointment for 1959-60; First Year Resident, Department of Internal Medicine, A.U.H.

SAMIR SALAMUN
Machghara, Lebanon.

Caduceus, Class Reporter, 1959.

Appointment for 1959-60; Fellow, Basic Science Course in Ophthalmology, Graduate School of Medicine, University of Pennsylvania, Philadelphia, Pa., U.S.A.





FAYIZ SALWAN

Aitanite, Lebanon.

Appointment for 1959-60: Residency training in Surgery, Cleveland, Ohio; U.S.A.

KAYSAR SHIDYAC

Aleppo, Syria (U.A.R.).

M.S.S. Cabinet, Secretary, 1956-58.

West Hall dramatic group.

University Choir, Member.

Appointment for 1959-60: First Year Resident in Internal Medicine, University of Oklahoma Medical Center, Oklahoma City, Oklahoma; U.S.A.

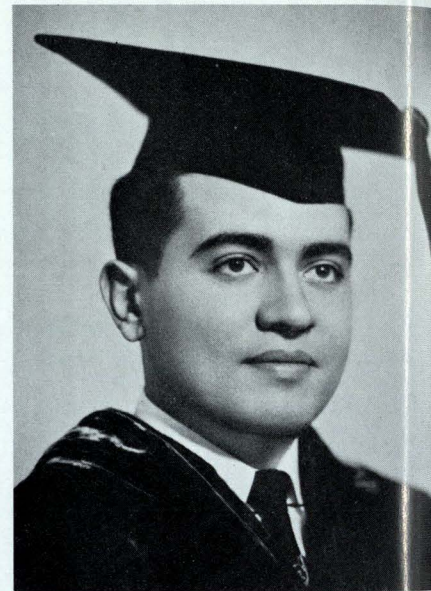

WADI AS-SUKI

Khartoum, Sudan.

Biological Society, President, 1953-54.

M.S.S. Cabinet, Vice President, 1957-58.

Outlook Editorial Board, Medical School Representative, 1956-58.

M.S.S. Bulletin, Medical Editor, 1958-59.

Caduceus, Class Reporter, 1959.

Alpha Omega Alpha Honor Medical Society, Member, 1958-

Appointment for 1959-60: Clinical Research Fellow, Department of Experimental Medicine, University of Texas, Southwestern Medical School, Dallas, Texas; U.S.A.



ABRAHA TEDLA

Asmara, Ethiopia.

Varsity Football Team, 1951-53.

Ethiopian Student Organization, Vice President, 1956-57.

Appointment for 1959-60; To work for the Ethiopian Government.



FIKRE WOLDE GEORGIS
Addis Ababa, Ethiopia.

Appointment for 1959-60: To work for the Ethiopian Government.

SAID ZU'BI

Yaduda (Hawran), Syria U.A.R.

Hop Step & Jump Champion, 1956-58.

Medical School Football Team, Captain, 1955-56.

M.S.S. Athletic Committee, Chairman, 1957-58.

Bowling Club, Chairman & Champion, 1953-59.

Oldest athlete for Autumn Field-day (Olympic oath), November 1958.

Appointment for 1959-60: Straight Surgical Intern, State University of New York Upstate Medical Center, Syracuse, N. Y. ; U.S.A.

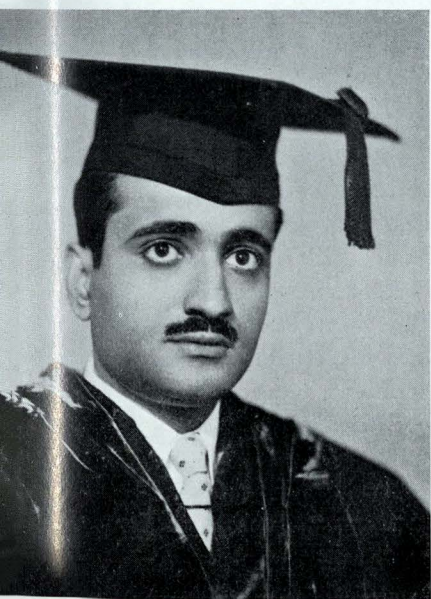

IBRAHIM YAKUB

Moharraq, Bahrain.

Active member of the Bahrain Link for combatting tuberculosis & illiteracy.

Appointment for 1959-60. First Year Resident, Department of Pediatrics, A.U.H.

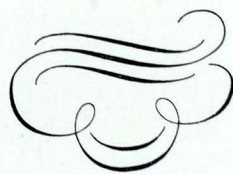

THE ROTATING INTERN *

After two years of basic medical education and two years of clinical clerkship, the student of medicine assumes a new status, namely that of a ROTATING INTERN. This new role is embarked on with renewed energy and zeal, for undoubtedly it is an important milestone that marks the end of the stage of defined duties and the beginning of years of service.

On assuming his new role, the intern comes face-to-face with an awful but venerable creature — one that goes by the name of Responsibility. He is given his share in the responsibility for the life and well being of the patient. However, this responsibility varies over the whole range of the spectrum. In the E.E.N.T. Department, for instance, this responsibility runs at a low ebb. There the interns would do very well to assume the mental attitude of an audience bewitched by the staged scenes that are being played by the Grand Performers. We should not overlook one of the vital responsibilities of interns in that department — namely that of taking down in short hand the findings that were revealed to the Master Examiner in the mysterious setting of the dark room. But unfortunately for the bodily comfort of the intern, and fortunately for his mental satisfaction the «audience attitude» does not persist throughout the year. For in the department of Internal Medicine (and also elsewhere) the intern is cordially invited to join the ranks of the Performers.

In the complex of the hierarchy of the hospital house-staff, the position of the intern is at the bottom of the ladder. When it is a question of blame, of course, the natural tendency for it is to gravitate downstairs (may Newton's bones rest in eternal peace). But when a good thing is accomplished and Credit is to be given, much to the surprise of Nature, it flows upstairs (Newton's bones shake in horror). As if having a tightly scheduled timetable is not enough for the intern, in addition he is expected to realize it with militaristic precision. This spirit of militarism is most outstanding in the surgical service where regimentation and discipline dwarf even the highest of the Spartan standards. Clichés as — «Chief», «Big Chief», «Assistant Chief», «O Kay Chief», in common usage in the department of surgery, merely symbolize this spirit.

The greater part of the day is spent doing routine work. This includes needle work, orderly work, laboratory work and clerical work. The intern salutes his day with the intricate Ceremony of the Bloods. Amidst the shuffling of the requisition papers the clinging of the tubes rise the protests and the screaming of the patients. As if getting exhausted and unpopular with his patients is not enough, the intern (usually) has to conclude the ceremony by supplying a specimen of his own blood to serve as a control. Occasionally there are great surprises when the laboratory results are reported, and one is left at a loss in determining who the patient is and who the normal.

So much of our time is spent within the hospital that the place assumes the familiarity of a Home. There we work, study, eat, sleep and carry a score of vital functions. At this point one should recall what the word INTERN signifies: one who is confined within the hospital walls. We shall never forget the OPD dormitories that were most generously allotted to us; for in comfort and facilities they cannot be surpassed. There, uninterrupted sleep is an unknown entity for when an intern is called, the hospital gateman awakens all the others before he can identify his victim. The investigative spirit with which some of our colleagues are endowed has discovered some endless opportunities for research in the sleeping quarters of the interns. Among the experiments conducted this year are those on the «Nocturnal Action of Various Snuffs» and the very promising new Extracorporeal Diuretic Measures.

Over and above his heavy responsibilities and the strict discipline that is imposed, the intern is constantly concerned about his medical future. He spends a good deal of his time and energy writing letters and applications and weighing the various possibilities for his further medical training. But in spite of all the above, the human touch is never lost; for during the year of internship many of us find their partners and commence their marital life. Others, however, emerge as more established bachelors.

The members of this graduating class of Rotating Interns have been associated with each other for quite a number of years — in a few cases for as much as two decades. We have known each other as playmates, friends and in the last few years we were moulded together in medical training. This year, unfortunately we did not have the chance to meet together as much as we used to for reasons which these lines make obvious. Moreover, the time has come for the brothers to scatter heading in different directions. But Hope never dies — for the Interns of 1959 have pledged to have a class reunion in 1984.

So until then, good bye, my brothers.

* RAJA N. KHURI



FAROUK ABUL-DHAHAB :
"No Coward Soul is mine....."

E. Brontë



ADIL BIRBARI :

*"It is a great ability to be able to
 conceal one's ability."*

La Rochefoucauld



MAURICE BARUDY :
"Happiness is speechless."

G. W. Curtis



FAWZI ILIYYA :

*"Don't you wear warm fleecy flannels?
 Don't you muffle up your throat?
 Don't you like to have one help
 you when you're putting on your
 coat?"*

O. W. Holmes

RASHID FULAYFIL :
*"It is almost a definition of a gen-
 tleman to say he is one who never
 inflicts pain."*

Cardinal Newman



RAJA KHURI :

*"A nightingale dies for shame if
 another bird sings better."*

R. Burton

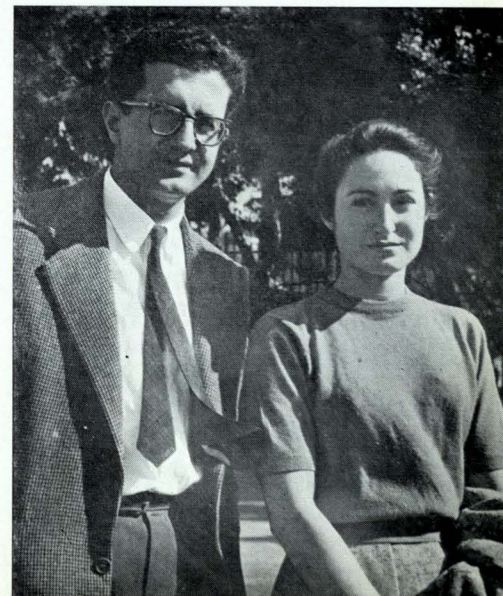



RAIF JABIR :
"The more haste the less speed."
 English Proverb

ISKANDAR JIHA :
"The tree of knowledge."
 Genesis II

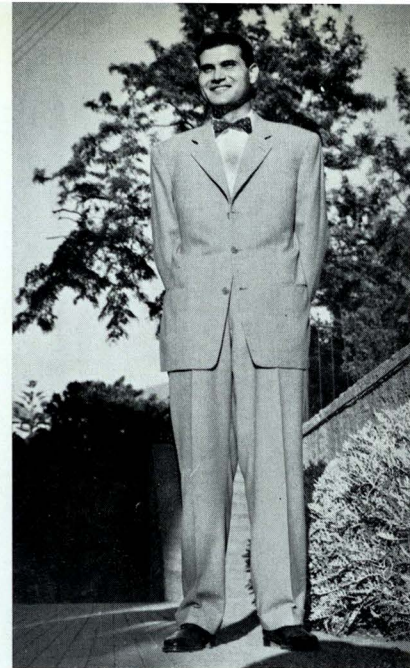

SAMIR JAHSHAN :
"Man is a mere character in a comedy."
 La Bruyère



AKLOG HAPTE-MICHAEL :
"A good heart is better than all the heads in the world."
 E. W. Bulwer-Lytton

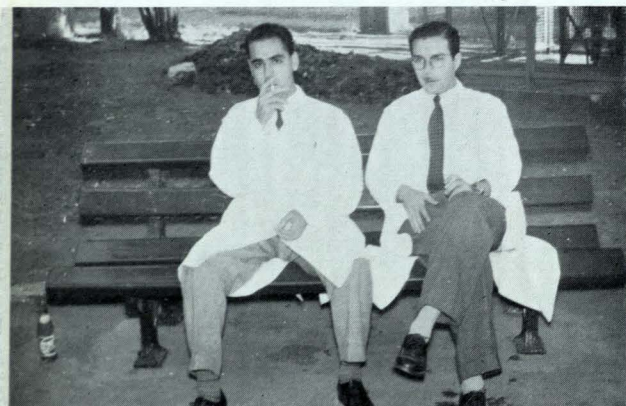

RIYAD KHALIFAH :
"The most useless day of all is that in which we have not laughed."
 Chamfort



WIDAD KIDANE-MARIAM :
"Other people are quite dreadful. The only possible society is oneself."
 O. Wilde



ILYAS LUBBAT :

"If you sleep till noon you have no right to complain that the days are short."

T. Fuller



MUNIR NASSAR :

"Life is so short, so fast the love hours fly, we ought to be together you and I."

H. Alford

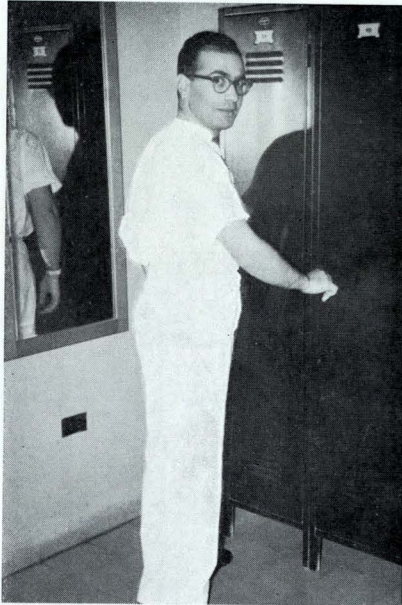

SAMI NASSAR :

"War is the only proper school of the surgeon."

Hippocrates



ARA MADONIAN :

"The heart has its reasons which reason cannot know."

B. Pascal



NIKULA SAB :

"Coffee has two virtues: it is wet and warm."

Dutch Proverb



ATIF SA'D :

"To live by medicine is to live horribly."

C. Linnaeus

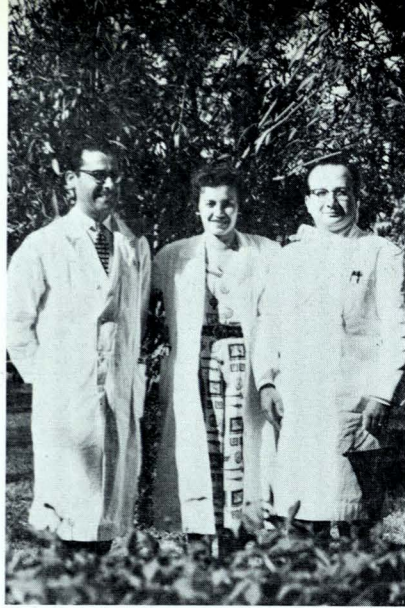

ANWAR RADWAN :

"The by-product is sometimes more valuable than the product."

H. Ellis

TATYANA RODENKO :

"Beauty is a good letter of introduction."

German Proverb

MICHEL RUBAYZ :

*"Who does not love wine, women and song
Remains a fool his whole life long."*

Johann Yoss



ANWAR RADWAN & FAMILY

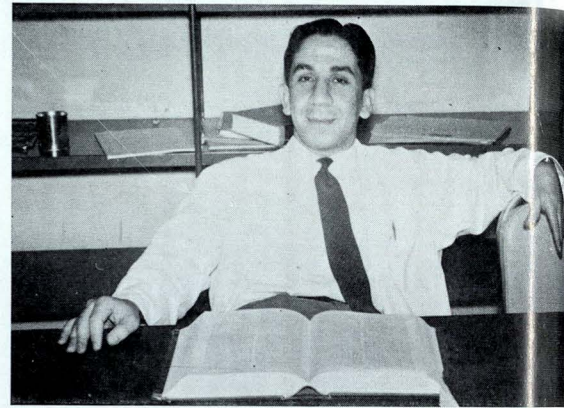

ALEXANDER SADIK :

"It is often wise to forget what you know."

P. Syrus



SAMIR SALAMUN :

*"A dance is a measured pace, as a
verse is a measured speech."*

E. Bacon

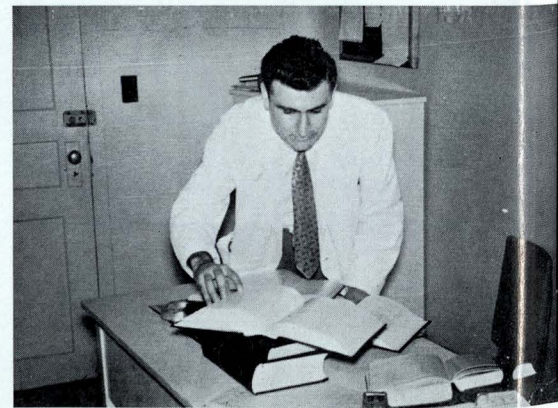

ANTOUN SALIM :

*"Be careful, and you will save many
men from the sin of robbing you."*

E. W. Howe

FAYIZ SALWAN :

"We boil at different degrees."

R. Emerson





KAYSAR SHIDYAC :

"On the stage he was natural, simple, affecting, 'Twas only that when he was off he was acting."

O. Goldsmith



WADI AS-SUKI :

"People who have no weaknesses are terrible ; There is no way of taking advantage of them."

A. France

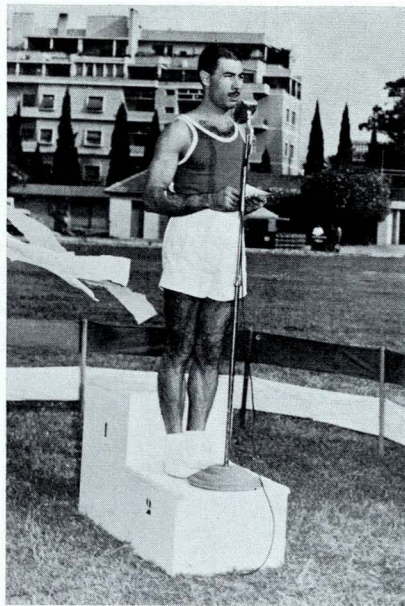

SAID ZU'BI :

"Who leaves the game loses. it"

French Proverb

ABRAHA TEDLA :

"I am as sober as a judge."

H. Fielding

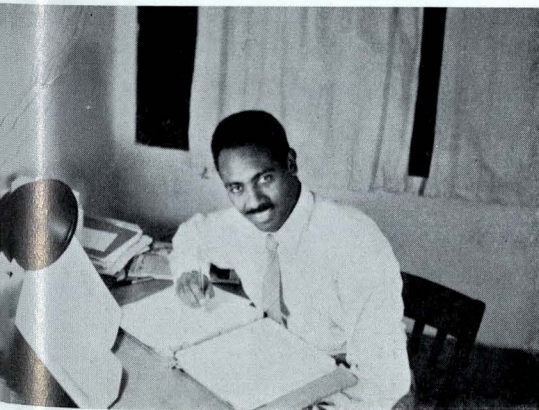

FIKRE WOLDE GEORGIS :

"Silence is deep as Eternity."

T. Carlyle



IBRAHIM YACUB :

"A man's grammar, like Caesar's wife, must not only be pure, but above suspicion of impurity."

E. A. Poe



CLASS EDITOR :

ADNAN DAJANI.

“Rest belongs to the work as the eyelids to the eye.”

R. TAGORE

CLASS OF 1960



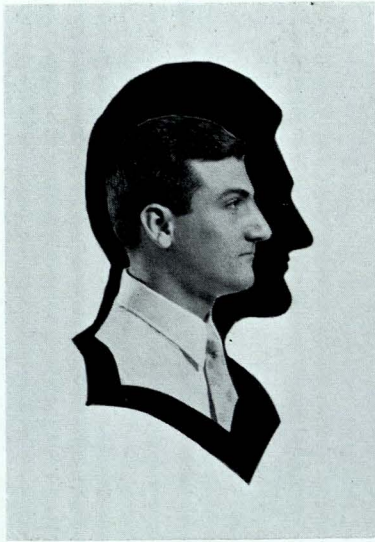

Nabil Adham



Maurice Atiyah



Emile Dabaj



Adnan Dajani



Bisharah Faris

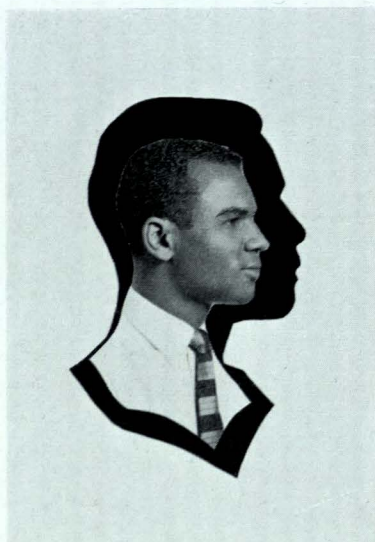

Adam Id



Henry Hadidian

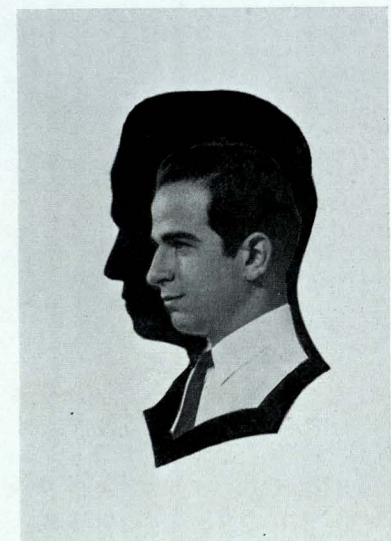

Jean J. Hajjar



Haroutune Babigian



Hanna Bitar



George Bridi



Syed A. S. Ghazanfar

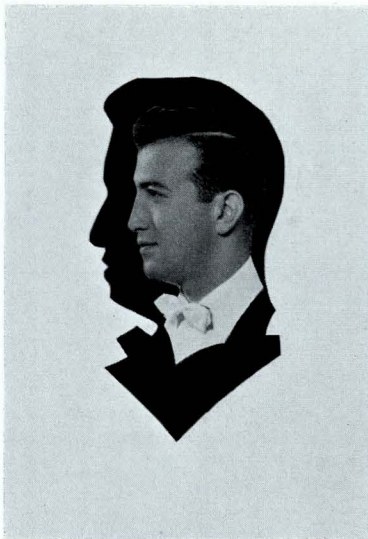

Henry Giragos

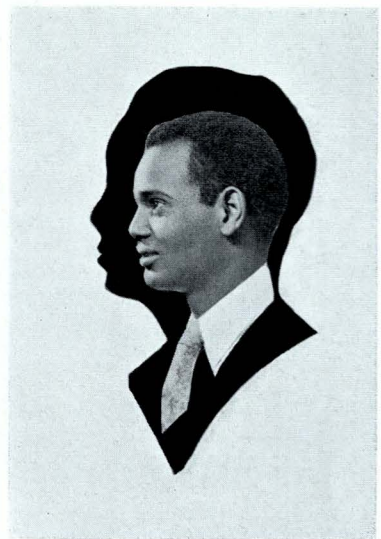

Gebrechristos Gobezie

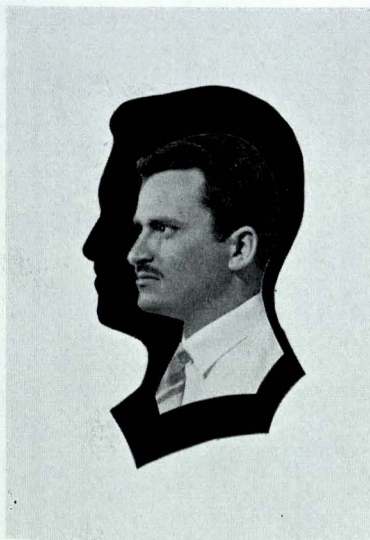

George Iskandar



Samir Kadi

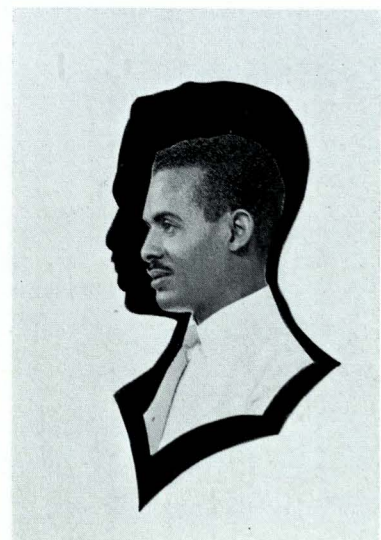

Tesfaye Kidane-Mariam

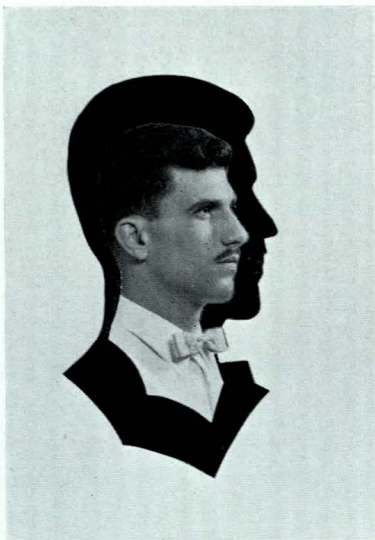

Jack Silah

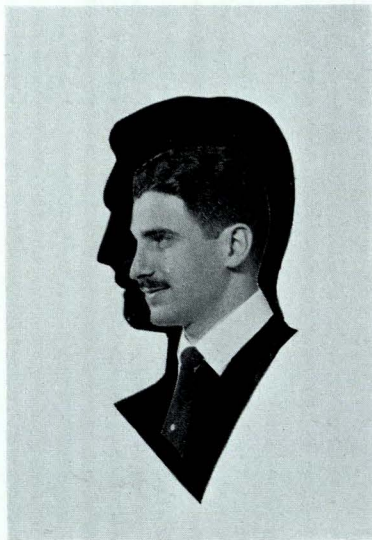

Hisham Majdhub

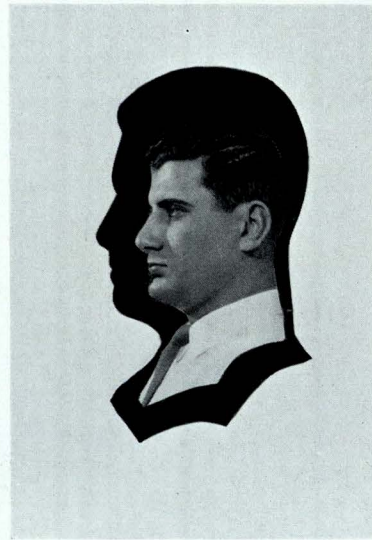

Zahi Makhkhalah



Isam Sakati

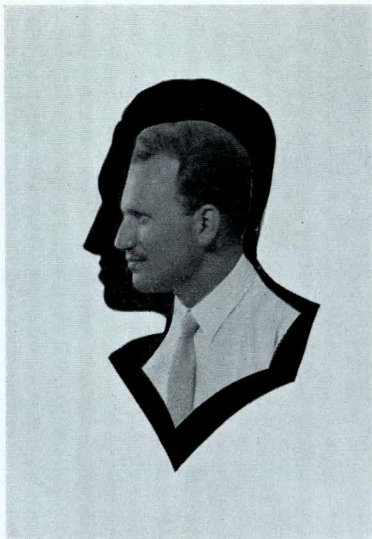

Maruf Razzuk



Richard Sabbagh



Muhammad Z. Shamma

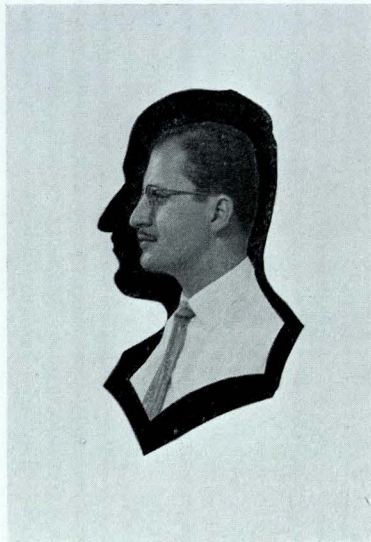

Wihbi Shuayb



Muhammad R. Taha



Aida Mango



Ohannes Jean Partamian

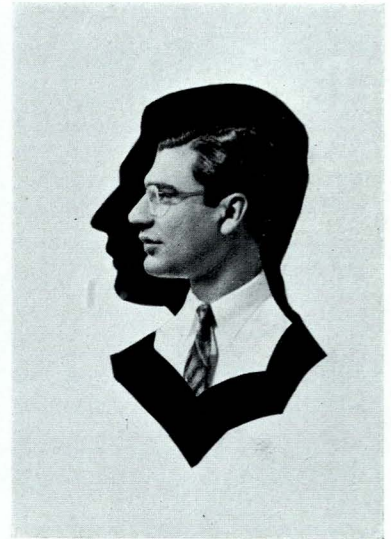

Rashid ar-Rashid



Shafik Sanbar



Edgard Sarrafian



Abdul-Muiz Shawar



Mohammad R. Waziri



Fahmi Zakariyya





Innocent fun at Club 21.

STATUS RELAXATUS

“And on the Seventh day God finished his work which He had done, and He rested on the seventh day from all his work which He had done. So God blessed the seventh day and hallowed it, because on it God rested from all his work which He had done in creation”.

Fourth year medicine is the seventh year of university education and in the seventh year medical students rest and rest abundantly. Unquestionably it is a year of Fun, Oblivion, Unscrupulousness, Relaxation, Temptation and Happiness. It is a year of relative non-existence — as far as acquisition of medical knowledge goes — where one has to refine his extramedical relationships, extend his extracurricular acquaintances, or else — vegetate.

Traditionally such was, is and will be the blessed and hallowed fourth year medicine. However, this picture is more true of the honourable class of 1960 than of any other class that was, or will be relaxing in fourth year. The reason for this is simple and evident: two “camps” have been cooperating to achieve an aim and their efforts were not wasted. On the one hand is the camp of Professors and on the other is the students’ camp, and in no other aspect of medical life did these two camps cooperate more profoundly.



Relax.



The acts of people are really not unbased.

In their unsuccessful attempt to raise the educational standard of the Medical School, the faculty members have contributed the lion's share to the present status of fourth year. With the abandonment of the "old regime" of BLS, not only did our whole-heartedly devoted professors gain a few more hours to spend in the coffee shop and at the Alumni Club or enjoy a longer and more pleasant week-end at the Cedars, but the long established reputation of fourth year as a state of physical relaxation has been artistically touched upon to become a state of complete mental, physical and educational relaxation — a state preferentially referred to as Status Relaxatus. They naturally argue that clinical students are on a postgraduate standard and that lecturing, like spoonfeeding, is only fit for children. Postgraduates we are indeed, but only in a certain way, for behold — we are treated like a Maternity residents when we assemble in front of patients.

Nothing depicts the lady and thirty-three gentlemen better than a famous saying by a famous teacher that "in this class there is a wide range of characters from the pastor to the bastard". Undoubtedly the shift is more towards the b —.

A heterogeneous group of capricious individuals having nothing in common except taking things the easy way, the present fourth year students are indeed unique. Opportunists they are with no time ever "wasted" in the Library, except, of course, when they have to meet a sister or see



When the bugle sounds.



Surgery staff room - قوة النشاط

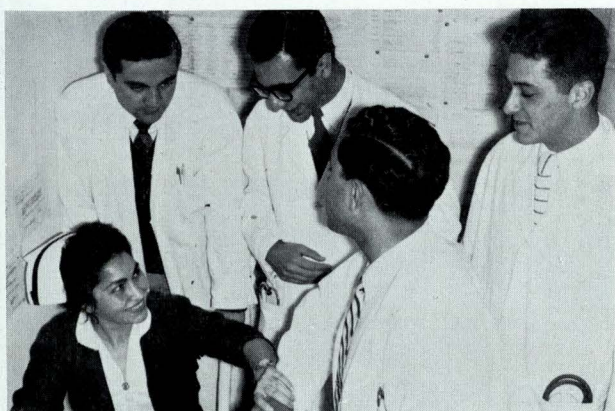

The Mecca of medicine IV.

a brother. Faced with an enormous amount of work and confronted with an overwhelming quantity of reading material, one must, for the sake of one's wellbeing, relax a couple of hours a day. Sleep being a luxury, according to the more experienced staff, the exhausted fourth year students have to relax otherwise. The more pleasant equivalent of sleep is alcohol, and so it is not at all surprising to find quite a respectable number of students indulging into this recommended habit almost daily. A Tom Collins at Sam's, a Bloody Mary at the Stork, a Screwdriver at the Dolls and finally an Old fashioned at Club 21 and all the troubles and worries are over.

More hours of innocent fun are spent at Club 21 than at any other place, including OPD; yet alcohol is by no means the only indulgence. Some

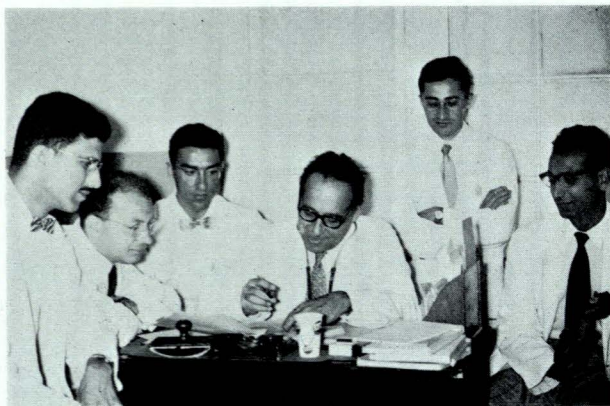

Hematology clinic.

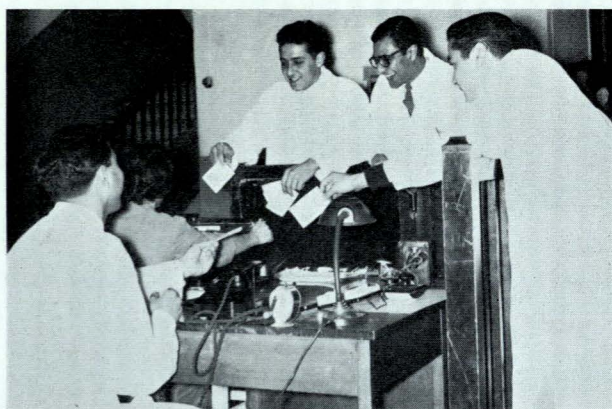

Asking for "Appointments."

spend their free-time playing bridge, trump or "likha"; some still have a few fetal remnants from the school of Arts and Sciences and are thus occasionally seen on a tennis court or on the green field; a few organize trips over the week ends and the rest vegetate. All these being earthly worthless acts, one student has spiritually purified his soul and dedicated all his free time, and even some of his curricular hours, to lead people along the only path to the eternal Kingdom of the Lord.

With this colourful picture of fourth yearers at hand, let us now have a glance at the gloomy one they have to face.

Sixteen weeks in Medicine enlighten the students that, after all, "supratentorial" affections are not rarities. After the cases are worked up by the "young clinicians" they are checked by the

resident, who, in turn, selects the interesting ones for microdissection by the attending. The dissection more often than not turns out to be gross; that is when the busy attending ever has the time or effort to dissect. Awaiting a verdict, the poor patient spends some five hours only to hear that more extensive studies by more experienced specialists are necessary. Thus to a specialty clinic he is referred, as the case may be thought to be but frequently turns out not to be.

In the specialty clinics students are lucky to be in two of them at the same time, but are usually in neither. Here one learns spot diagnosis, hears the latest news of Embassies, and above all sees the Rock'N Roll in the sixth interspace.

A rather better organization is met in Surgery. The morning starts with a discussion which varies in spectrum from a pure spoonfeeding to a bitter unjustified criticism. The busy surgeons are to be constantly reminded of their next-morning discussions or else they feel offended. In the Surgery staff room anything but surgery is discussed, and at times discussions are not only verbal. The Saturday grand rounds are intended to be "for the sake of the students" but are at times a field day of show business. Again "for the sake of the students" patients are admitted to the OPD clinic by the dozens. The student, naturally, for his own sake, has to work up two or three cases inspite of time and inspite of himself. The minor surgery clinic has nothing peculiar except that some procedures may at times turn out to be major.



The latest news of Embassies.

In Pediatrics interests may vary. The novelty is the mothers' class where not infrequently the maternal instincts seem to excel the students' fragmentary knowledge. Taking a history is an art, making a physical examination is a challenge and reaching at a diagnosis is an absurdity. Yet children do well inspite of everything but their mothers suffer for them.

The two places where students learn are the Skin and EENT clinics. Undiagnosed dermatologic cases by the students even after prolonged contact are spotted in a second by the Master at a meters distance.

In EENT absolute military order prevails. Stunents are constantly threatened to be thrown out of a window if they ever attempt to disturb the harmonious arrangements of the place, or if they ever forget to remember and remember too that details are as important as generalities.

Asfourieh is a real splendord experience. Being in close contact with a variety of "personalities", one is surprised how many such similar ones are actually living outside. It is after the psychiatry course is over that one realizes that for every impulsive act there is an underlying stimulus. One learns that a person detesting smoking does so because he was denied it when he yearned for it, and that projection is only a natural defence mechanism. It is then that one starts to appreciate that the acts of people are really not unbased.

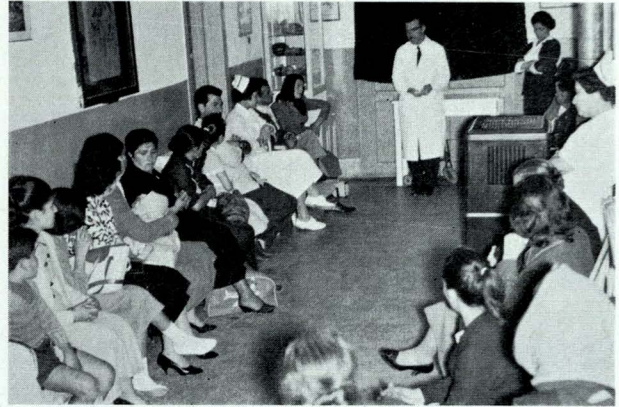

The novelty of pediatrics.

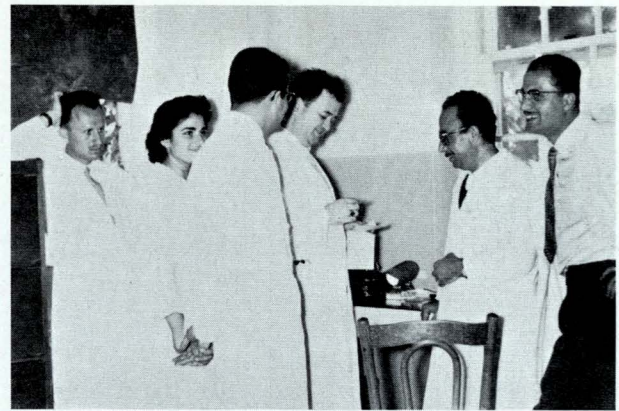

Hematology pediatrics.



The path of glory.



In pediatrics interests may vary.

CLASS EDITORS :

BERNARD A. ISAAC.

SUHAYL SALEH.

RAJA K. KHURI.

*“Man does not reveal himself in his history, he struggles
up through it.”*

R. TAGORE

CLASS OF 1961

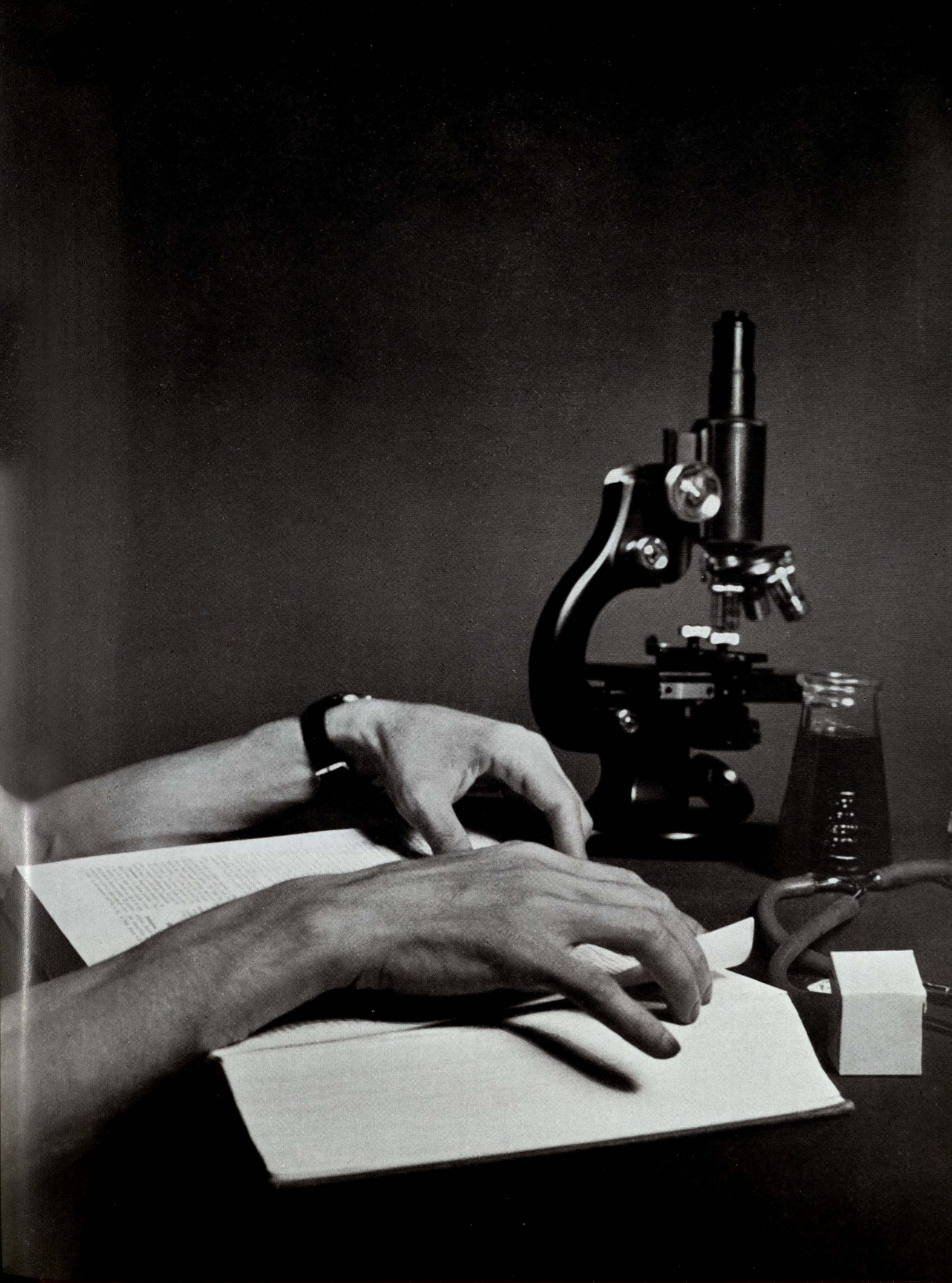

THIS IS THIRD YEAR

As students in general, we see relief in the class ahead of us. Whether after passing through second year third year is really so, or whether the task of learning medicine is alleviated as one is promoted from class to class remains to be judged on personal basis.

The work we have done has been similar to what previous third yearers have performed. The purposes we have been after are what others before us have sought. The setting has not changed much: we have changed and the future shall change us further, but the memories of third year are there for us to cherish.

"IN THE BEGINNING WAS THE WORD...."

Dep't of Obstetrics & Gynecology.

The hours pass odd and even*
In the Delivery Suite.
Mary's now born, then it's Steven
Dawn will break and birds will tweet.
Comes a woman in active labor
And the pain is much too great.
Scopolamine and Demerol
"Curse you doctors, nurses, all!
Oh, have pity on my state
I'm about to defecate.
If in one way or another
Oh dear sister, Oh dear brother
Help me! Help me!" does she stutter,
"Get the baby out of me".

She is ready to deliver.
Nurses rush and doctors brush
The head is showing, hurry, hurry
The baby's out and it is over.
"Tis a boy, Oh how sweet.
Tis a girl woe is me. »

The mother relaxes, duty done
Comes another ain't it fun
Doctors, nurses up all night
Morning they are quite a sight.

The hours pass odd and even
In the delivery suite.

*BY RAJA K. KHURI

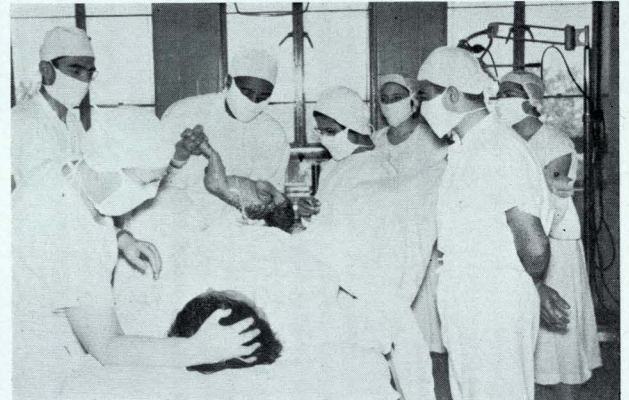

"In the beginning was Word....."

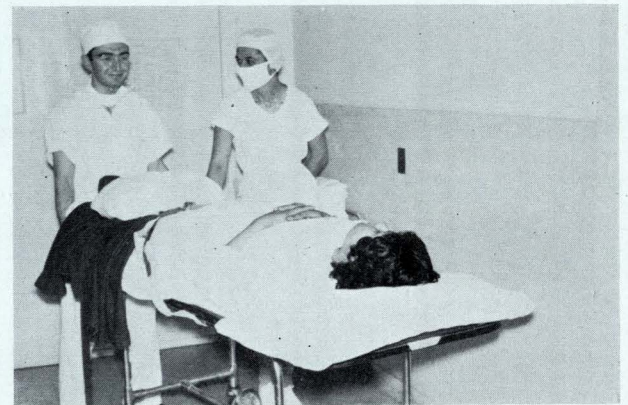

When orderlies are not available, the third yearer takes over.



Yak, yak, yak, so the gossip goes around.

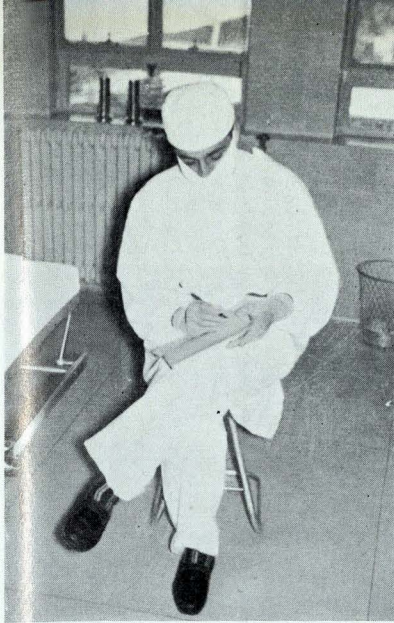

Writing poetry in the Delivery Suite !!



The spacious sleeping quarters.



Expected ! another admission at 2 a.m.

In the Gyn. and Obs. department, the third yearer is given more chance to feel responsible. He stands as the star of the "show" in the Delivery Suite, the center of attraction in O.P.D., and the expert technician in Womens II. He carries his responsibilities faithfully hoping that his superiors will not interferé. He belongs to one big happy family, where whatever he does or says is immediately circulated around.

The importance of sleeping during a free moment in the Delivery Suite cannot be over stressed. This is such a well recognized fact that the comfort and peace of mind of the student are well taken care of. He has been provided with the best part of the fifth floor corridor for sleeping quarters in a double-deckered creaky bed. There the student is lulled to sleep by the music of the elevator going up and down. Whenever he hears its sound, he is thrilled by the happy thought that at two o'clock in the morning he shall be called to do a urinalysis and hemoglobin on a primipara admitted in early labor, or at 5 a.m. when he prepares a patient for the next comer.

Occasionally he is consulted for a home delivery. Having failed in his consultation to bring forth a normal delivery, he transfers the patient to the hospital to the anguish of the revered residents.

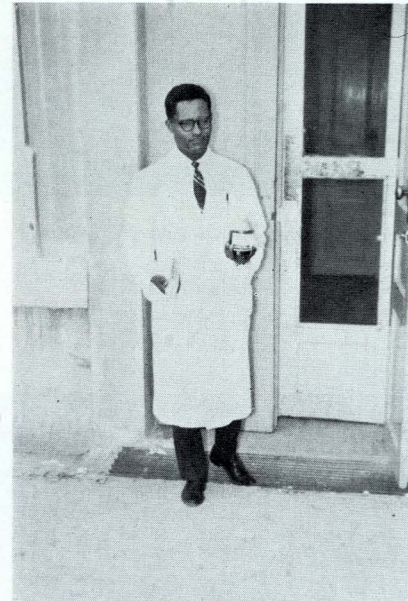

Functional uterine bleeding, "Hurry up Shimellis"

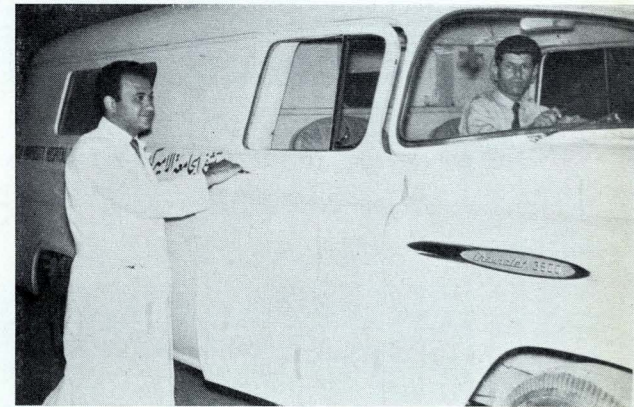

The Flying Dutchman of home delivery service.

Waiting for the residents to impart knowledge on us !!!





Social session at 10:00 a.m.

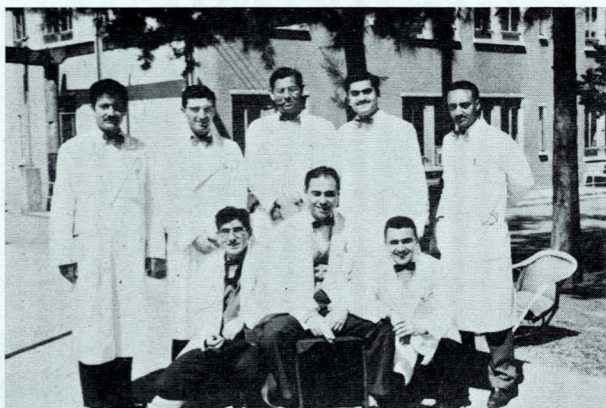

Papillon group on papillon day



They even have time to read Outlook.

"A CONGENITAL ANOMALY"

Dep't of Pediatrics.

The luckiest group of students in the class are those who go to pediatrics during the last months of the year. It is the beginning of spring and for these students it is the time when they enjoy it most. The third yearer swims or plays volleyball in the afternoon, goes to the movies at night, wakes up late in the morning — not before 9:00 am — puts on his bow tie and is ready for the 10:00 o'clock social session.

If he happens to sneak into the morning rounds, certain "unblinking eyes" will make sure that this intrusion will not be repeated.

Basic training in Pediatrics includes practice in the formula room and nursery. This will make sure that he will not forget his milk formula and will also teach him how to change diapers and wash babies expertly. He may hear the nurses say through their giggles that the true purpose of this training is to make him an "Ideal Husband".

In the evening rounds, he feels real important and realizes his responsibilities fully, when his attention is drawn to an empty space in the laboratory sheet. The day may end with a stool exam, or if he is more lucky, a urinalysis.



"Easy on the nurses Farid, they are fragile."



"To feed them..."



A campaign for elections? No!
A poetry contest.

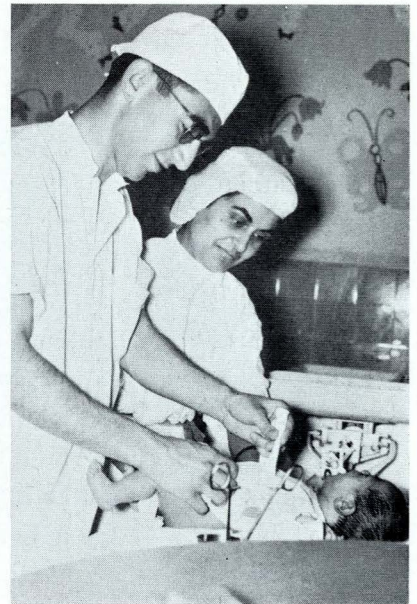

and to wrap them."

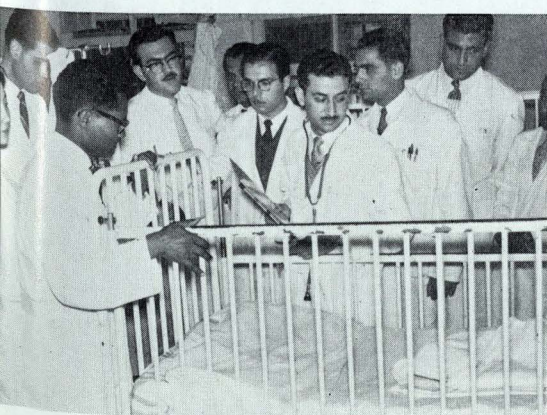

The evening round.

Look again Naim, maybe you'll find
that Giardia

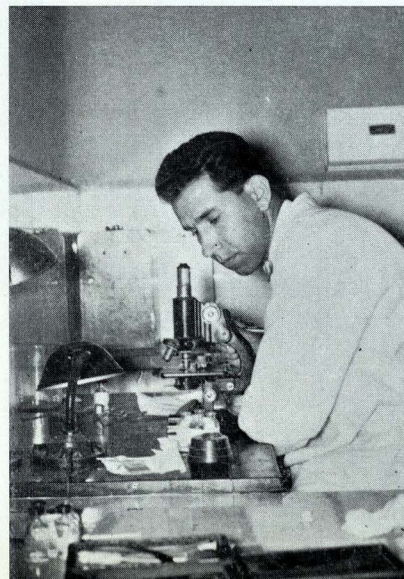

"THE CRUX OF THE MATTER..."

Dep't of Internal Medicine

In five tough months we pass through the department of Internal Medicine. We do realize that it is the place where we really begin to know how little we know. In other words we begin to be wise. But wisdom alone is the starting point. We have to study hard, be prompt and do the seemingly endless laboratory work. To top that we finally have to take a history from the patient after it has been taken at least three times. In doing this we have to be original and try to add to the interns' record. Some do it by elaborating on the patients sexual life and habits — with all due respect to the late Dr. Kinsey.

The new curriculum has relieved us from the sleepy 7:30 morning lectures and has kept our conscience clear in that we don't have to do numerous cuts. They have been replaced by 10:00 a.m. lectures where the professor enjoys himself in the coffee shop. The students soon follow suit and rush to the cafeteria for cakes and coffee and maybe a chat with the nurses. In the popular noon sessions the lecturer gives a glimpse, nay, a bird's eye view of the topic to a student body that barely constitutes a quorum.

Soon it is over and before we know it we are either sitting for a make up comprehensive or for all practical purposes we are fourth year students.



We are always in the background.

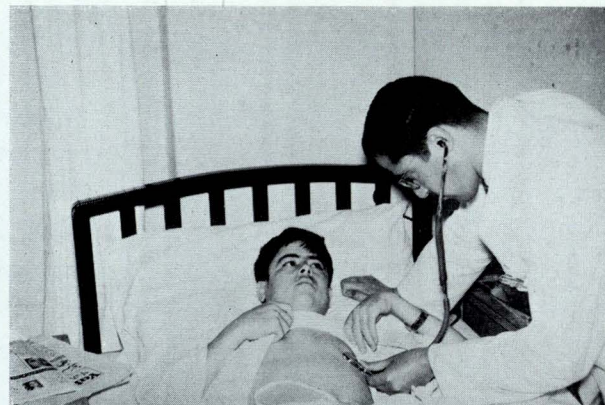

Auscultatory diagnosis : — shifting pacemaker.
"Get out the bands, burn the E.K.G.s, fire Rubeiz, here comes the savior."



The 10 o'clock informal session.

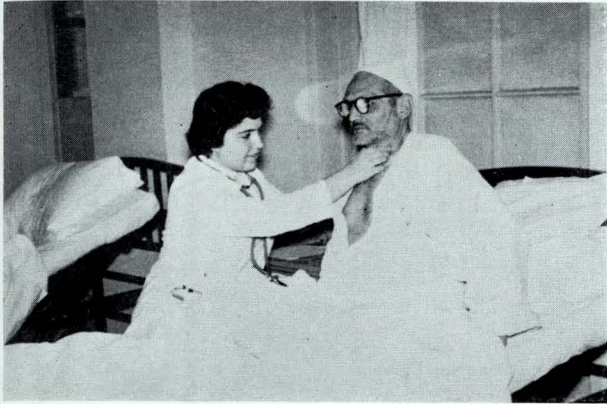

In a physical exam we start from up

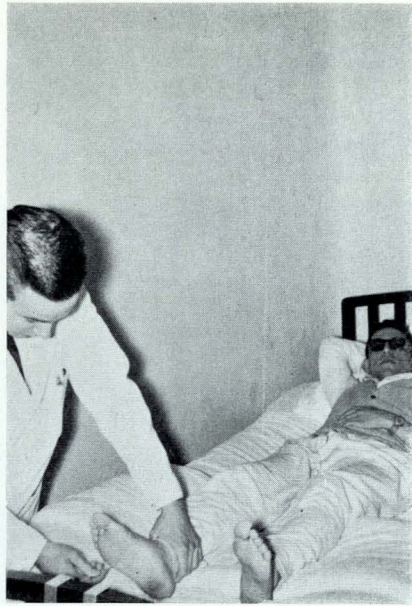

.... downwards.

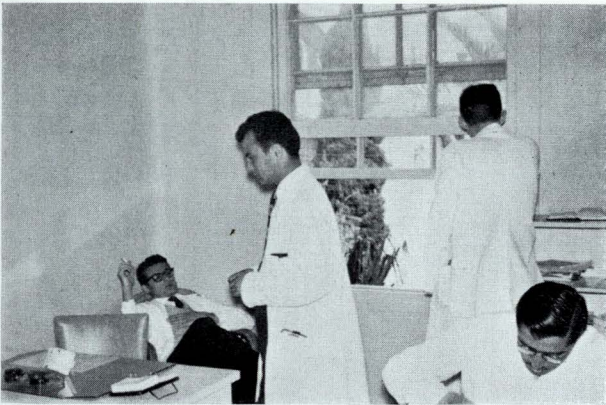

Anybody for a consultation.

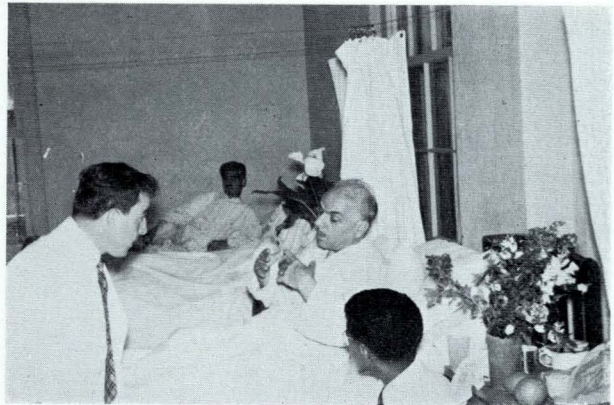

Overcoming a language barrier.



"We cannot wait any longer."



Few minutes later.

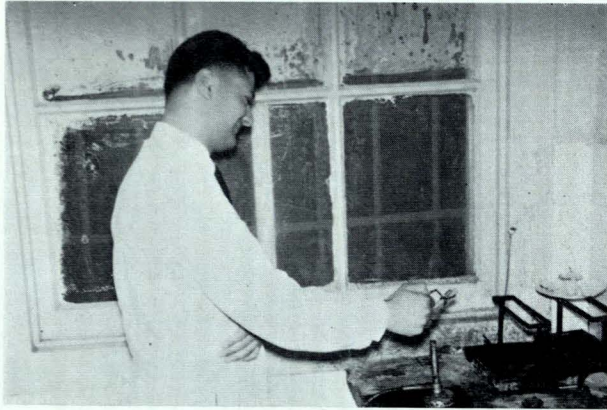

Scientific honesty, boiling the urine sugar for five minutes though the tube runs dry.



His resignation, was it due to the centrifuge or.....

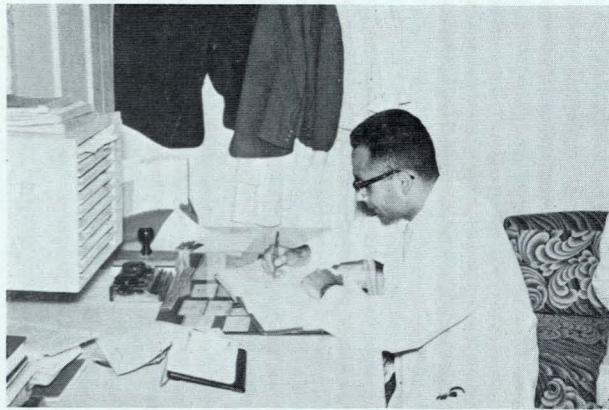

James Joyce's style is not a recommended method in history writing.
"Hratch, rewrite it."

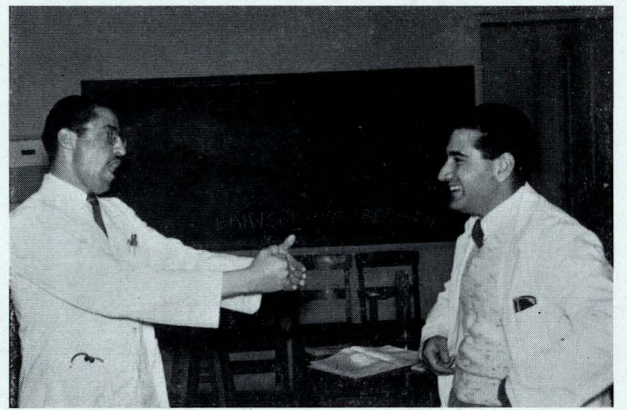

"Pap Pa pap pa"
"Nadim, you don't have to remind him of it"

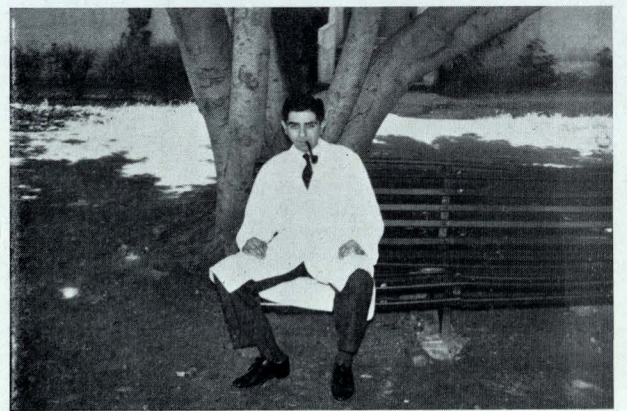

The lone ranger.

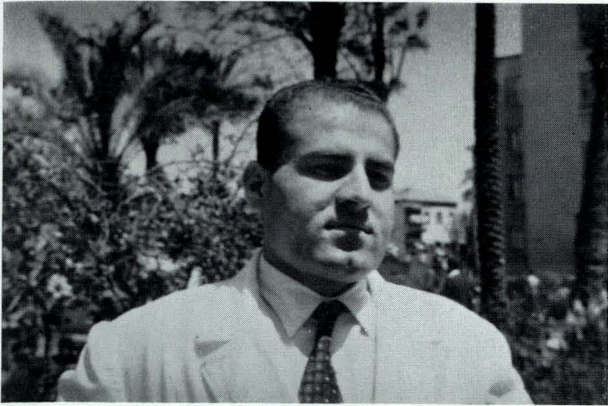

to the powerful personality of our hero.

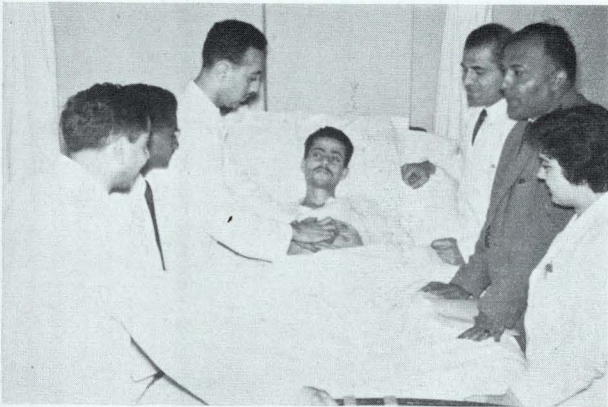

"Are you in our group Uwaydah."

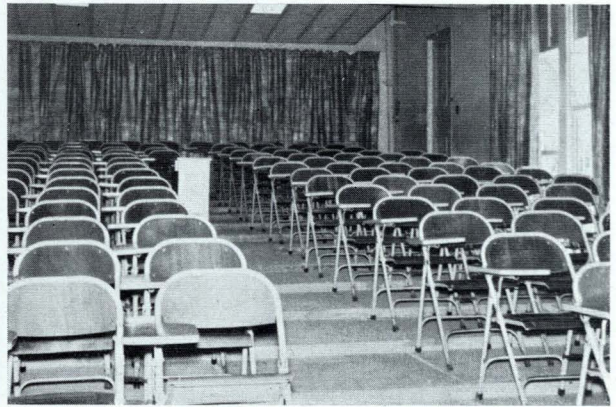

The popular noon lecture.



Studying in the Library.



10 minutes later.

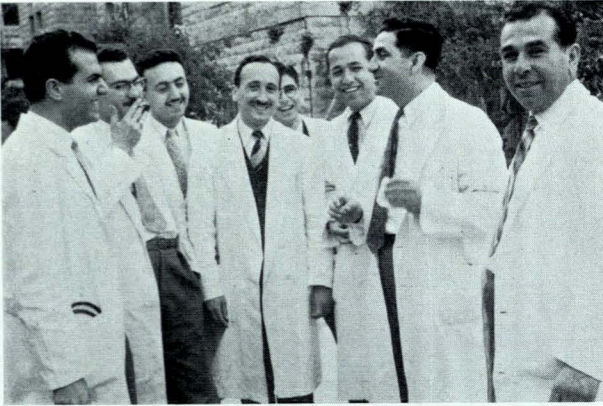

Baydouns !!!



Medical Students maybe anemic and undernourished...



... but are sometimes well off.

IDIOSYNCRASIES



Chez Garbis.



A game of "leekhah" late at night to refresh sunken spirits.



The inappropriate laugh for the inappropriate joke.



Hypo!!!

CLASS EDITORS :

MAURICE YUWAKIM.

EDWARD MANSOUR.

“It is the tears of the earth that keep her smiles in bloom.”

R. TAGORE

CLASS OF 1962

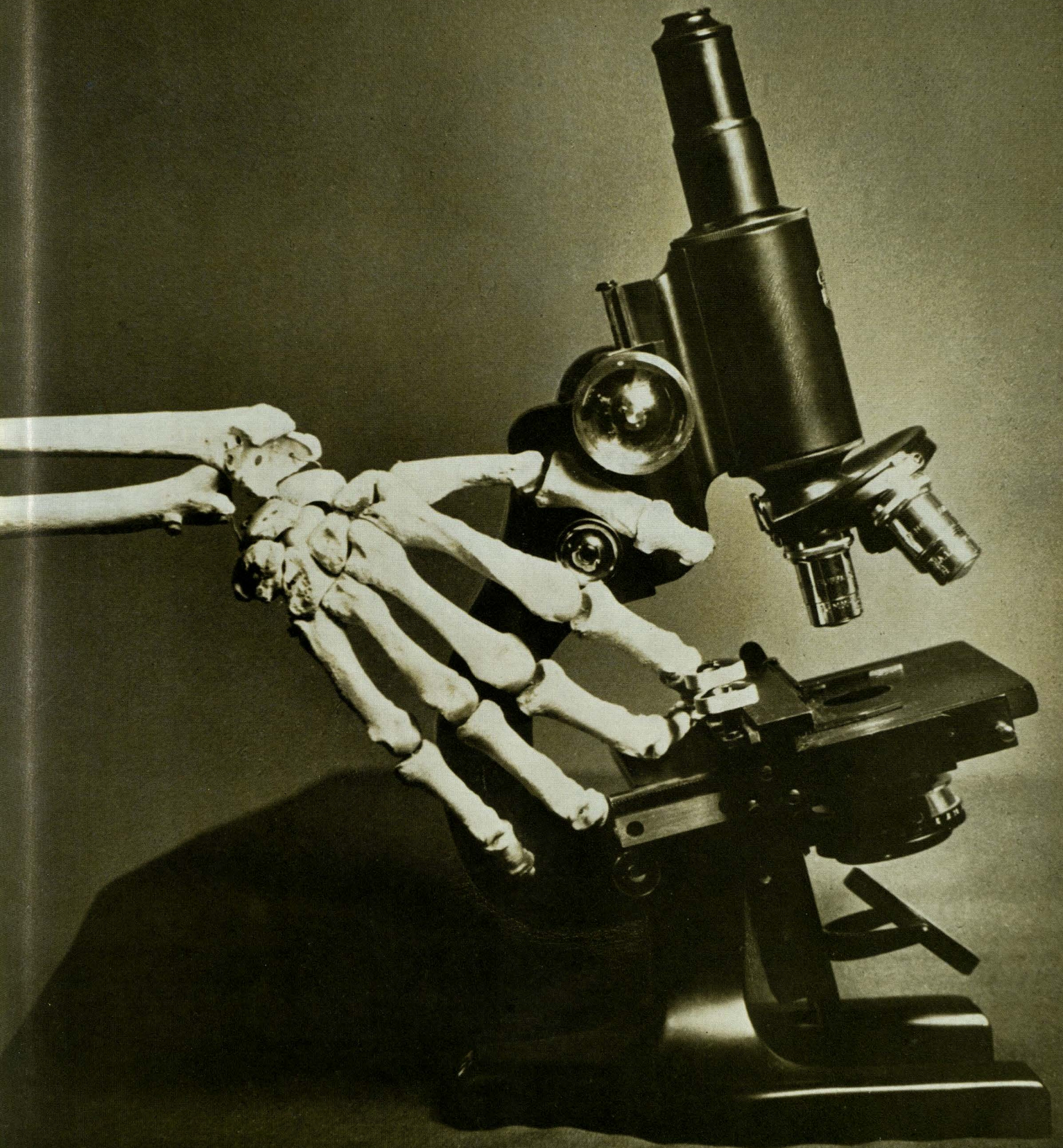

MEN AT WAR

Second year has always been a traditionally hard year. Oddly enough, it attempts at maintaining this tradition. Fortunately we know this, not because we are repeaters, but because of what our predecessors say, and what we experience day after day. It is as if one were constantly engaged in a deadly fight with courses, books, and quite often, with professors, who seem to have forgotten how overworked they were in their second year.

Everyone of our teachers, and we cannot understand how, or why, appeared convinced that his course was the only one to demand any work from us. Thus if we had a final in the afternoon, we had to attend regular lectures and laboratories in the morning. Of course, we learned nothing during those classes.

As second-yearers, we were not supposed to be human beings, but rather electronic recorders of facts. Lectures, scheduled to be fifty minutes long, never ended on time, most of them going up to seventy minutes. After such long lectures, we would be "granted" a break of 10, 11 or 12 minutes, sometimes up to 13'30", depending on the teacher's mood for the day.

In second year, extracurricular activities were implicitly taboo. Classes were scheduled to end at five, but make a five-thirty appointment, and you were sure to miss it, for the teacher kept you half an hour extra.



Between a lecture and a lab.



Group picture.

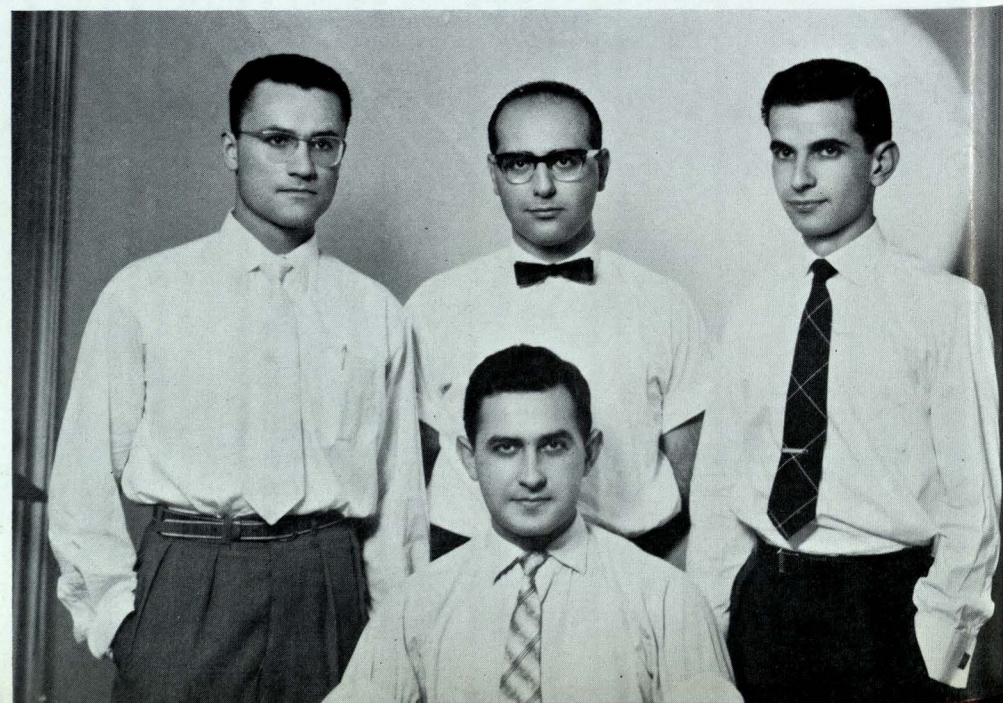

Seated :

Vatché Ayvazian.

Standing Lt. to Rt. :

Mundhir Al-Attar, Henry Bikhazi,
Fuad Ashkar.

Seated :
Miss Nadya Nassar.
Standing Lt. to Rt. :
Anwar Sinnu, Rifat Daghir,
Alberto Vincenti.



Lt. to Rt. :
Mahmud Kabbani, Yasir Ubayd,
Sami Kabbani.



Seated :
Ibrahim Dib.
Standing Lt. to Rt. :
Antoine Sabir, Raja Bahu,
Jean Rubayz.

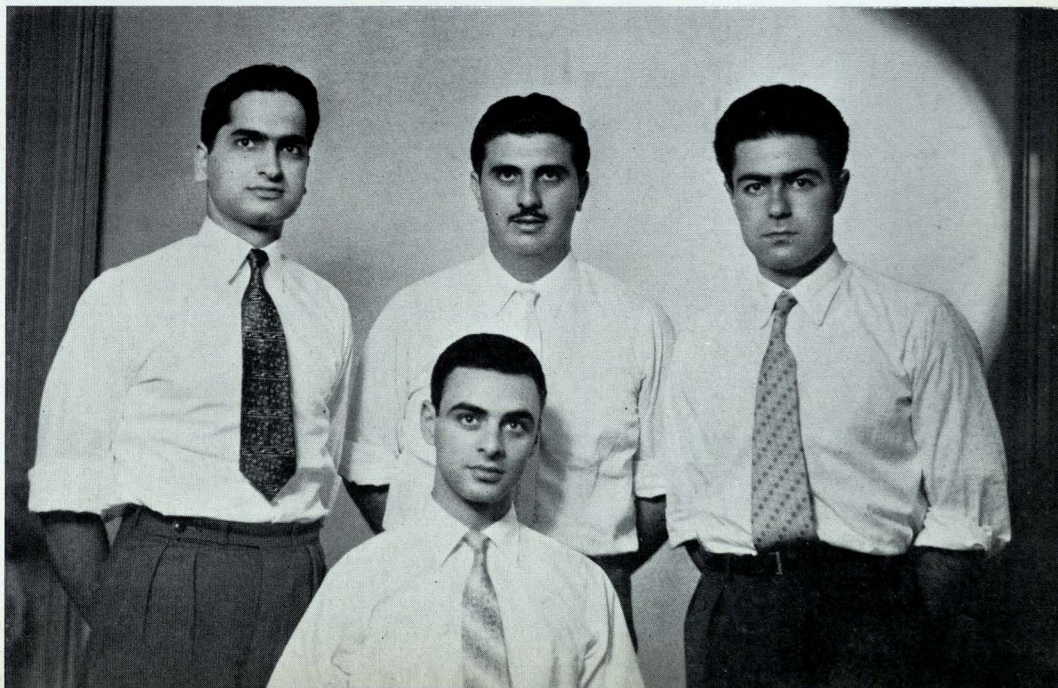



Seated :
Miss Rudayna Husayni.
Standing Lt. to Rt. :
Miss Najibah Abul-Husn,
Miss Aida Khazin.



Seated :
Isam Kublawi.
Standing Lt. to Rt. :
Salim Musallam, George Saadah,
Alexander Zakhariyya.

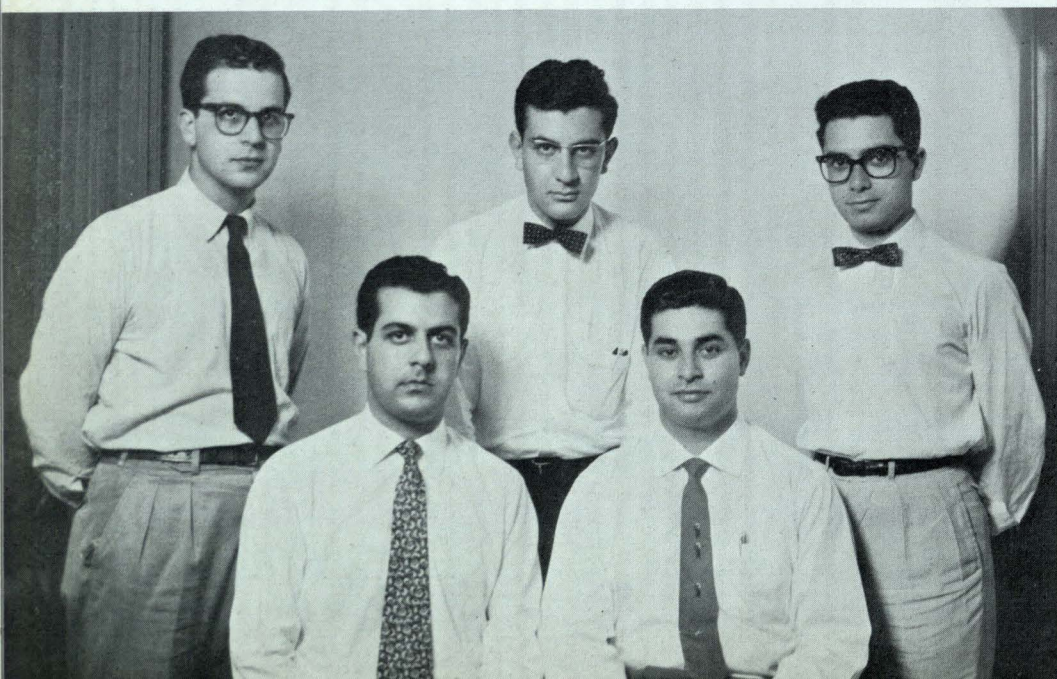

Seated Lt. to Rt. :
Edward Mansour, Kamal Bikhazi.
Standing Lt. to Rt. :
Munir Katul, Maurice Yuwakim,
Isam Shihadah.

Still we all realize that nobody is to blame for the flaws in the second year teaching system. We are sure, and so are our professors, that nothing can be done about it.

Just like all social animals, we reacted to the stress of the Medicine II War. The reactions were many and varied, but one feature was constant : most of us formed into groups, seeking in the class the sympathy we were not allowed to seek outside, and occasionally copying, from each other, a missed statement from a lecture (lectures sometimes go very fast).

Although Mundhir al-Attar, Vatché Ayvazian and Henry Bikhazi reacted to this year's stress by studying more and more (as usual),

Fuad Ashkar seemed to have deviated from his usual course. He studied less and less, even managed to get a "low" grade in the Parasitology Lab final, and yet was somehow on the Dean's List.

When Mundhir al-Attar and Henry Bikhazi argued a point, Attar was always sure to win because of his louder voice. It is remarkable that the more he studied, the louder his voice became. Henry, on the other hand, reacted to stress by dressing better, but this, of course was of no use in the arguments with Attar. Ayvazian was always the interested spectator, trying to keep them from coming to blows.

The time-honoured association between Rifat Daghir, Nadya Nassar, Anwar Sinnu and

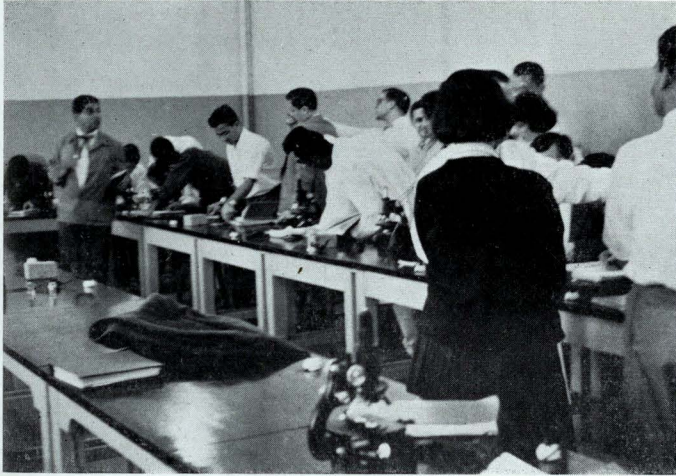

Let us go.



Relaxation Headquarters.

Seated :

Jirair Injéjik.

Standing Lt. to Rt. :

Hagop Mekhjian, Misak Abdulian,

Misak Barsamian.



Among those who abstained from participating in Sinnu's Cooperative were Mahmud Kabbani and Yasir (Cut-lab) Ubayd. With Sami Kabbani, they form a trio whose reaction to the stress was rather peculiar. Sami, as quiet and complacent as ever, managed to top the class during the first semester. He has apparently been able to resist Ubayd's persuasiveness and unyielding insistence in all matters. Mahmud, an unchangeable character, with a good-humoured smile and apparent disinterest in the world around, always suggested to us "vanitas vanitarum".

A group whose reaction contrasted vividly with that of the above, was composed of Ibrahim Dib, Antoine Sabir, Jean Rubayz and Raja

Alberto Vincenti was kept up this year. Undoubtedly, Dagher remained the self-appointed boss of the group, due probably to the fact that he is the tallest. The businessman among them proved to be Sinnu, who managed to form a cooperative of Medicine II students and teachers, and to plunge it in an adventure, by buying 25 tickets for the National Lottery. As for the result, better consult the group's Advertising Manager, Signor Alberto Vincenti of Florence, Italy, who tried, with Miss Nassar's support (both moral and verbal), to justify our loss and to convince us to participate in another attempt at getting the Grand Prize. It was clear to us that Sinnu was to blame, for he had, through his negligence, bought losing tickets.

Seated :

Berj Gueyikian.

Standing Lt. to Rt. :

Mamigon Garabedian, Haroutune Deyirmenjian, Raffy Hovhannessian.

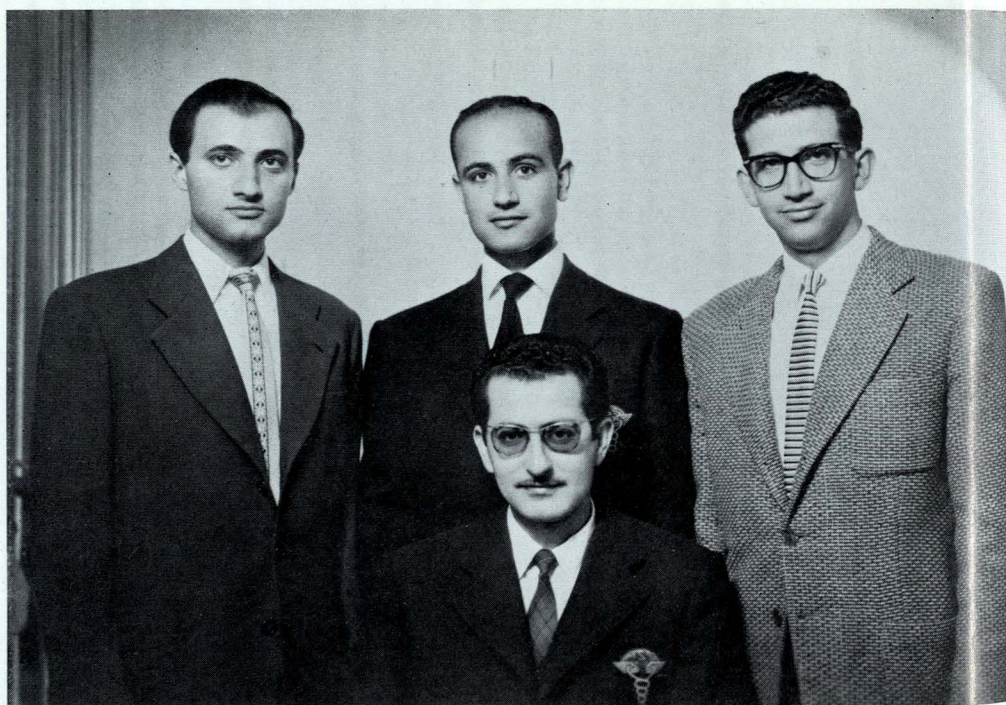

Fresh up with Seven Up.

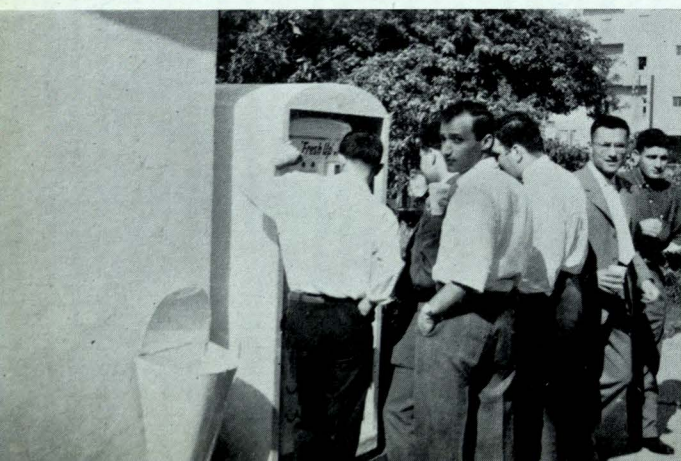

Bahu. These people mainly seemed to believe in "eye for eye" and "stand by your rights (and wrongs)". On the whole, they gave some spicing to a generally unsavoury year.

Abukurah and Bilbisi reacted in their own particular way to the stress of second year. It goes without saying that they, like all others, studied more. But that was not all — they sang more and recited more poetry (Arabic poetry, or course).

Even the unkeen observer could very well see that all the ladies were most interested in what was going on in the class. Miss Khazen, impassive as usual, took in every word that was

said. Miss Abulhusn, critical as usual, did not fail to record any of the multitudes of idiosyncrasies and mannerisms our teachers exhibited in class. It may be pertinent to say that her usual place in the amphitheater helped her a lot. Miss Husayni was in an exceptionally talkative mood all year long. She would, for example, ask a question and then not listen to the answer, only to ask the question again. It was all very interesting.

Isaac Abraha, silent and ever-smiling, went his way on the best of terms with all. Lectures about carcinogens did not deter him in the least from smoking several tens of "Stars" a day. Confidentially, he probably knew all about the d — carcinogens long ago. Fikre Workneh, a jolly good chap, passed the year being so pleasant with everybody, that everybody passed the year being pleasant with him. He proved that his likes were rare.

Second year did something to Salim Musalam, his eyelids drooped still more. We are sure this was not due to too much studying — it was rather due to his being bored in class most of the time. All this was perfectly normal, we were all bored and tired in class (especially in afternoons), but poor Salim could not help showing it.

Salim's best counterpart was Isam Kublawi, a good chap, and very efficient. He showed a distinct dislike for term papers.

George Saadah still kept up his orchestra standard (Caduceus 1958) even during the labs. This never failed to entertain the class. His

cheerfulness always surprised and warmed us. His friend, and ours of course, Alex Zakhariyya, was his old self, full of optimism and confidence in his own powers. Although he was going through as hard a time as we, he never seemed to like to admit it. Such fortitude is admirable but, in our humble opinion, hardly useful.

Katul, K. Bikhazi, Mansour, Shehadeh and Yuwakim formed a group full of ideas for reform. They found it impossible to understand why certain things had to be unpleasant when their more pleasant counterparts were as good. Most of them seemed to think that a teacher could be well-liked by the students if he treated them well. It is certain that these people had nothing original, but they said aloud what most of their classmates said in private.

An interested, active and important — wherever they are, Armenians manage to be important — group acted as moderators, and sometimes pretended to be bewildered spectators. Some of them (Hovhanessian, Garabedian) were interested in sports despite their being so busy. Deyirmenjian seemed to have outside activities of the most important, and interesting, nature. Bookseller Gueyikian kept the class well-supplied with books all year long (he gets them cheaper and faster).

Abdulian, Injejik and Mekhjian all participated in their own way in making our class a good place to be in. Abdulian always showed the gift of inoffensively laughing at the details others would quarrel about, thus cooling everybody down. This was often a useful procedure.

Seated :

Abdul-Aziz Bilbisi.

Standing Lt. to Rt. :

Fikre Workneh, Isaac Abraha.

Absent :

Abdul-Razzak Abu-Kurah.



CLASS EDITORS :

SUAD RAYYIS.

REUBEN SIRAGANIAN.

"That I exist is a perpetual surprise which is life."

R. TAGORE

CLASS OF 1963

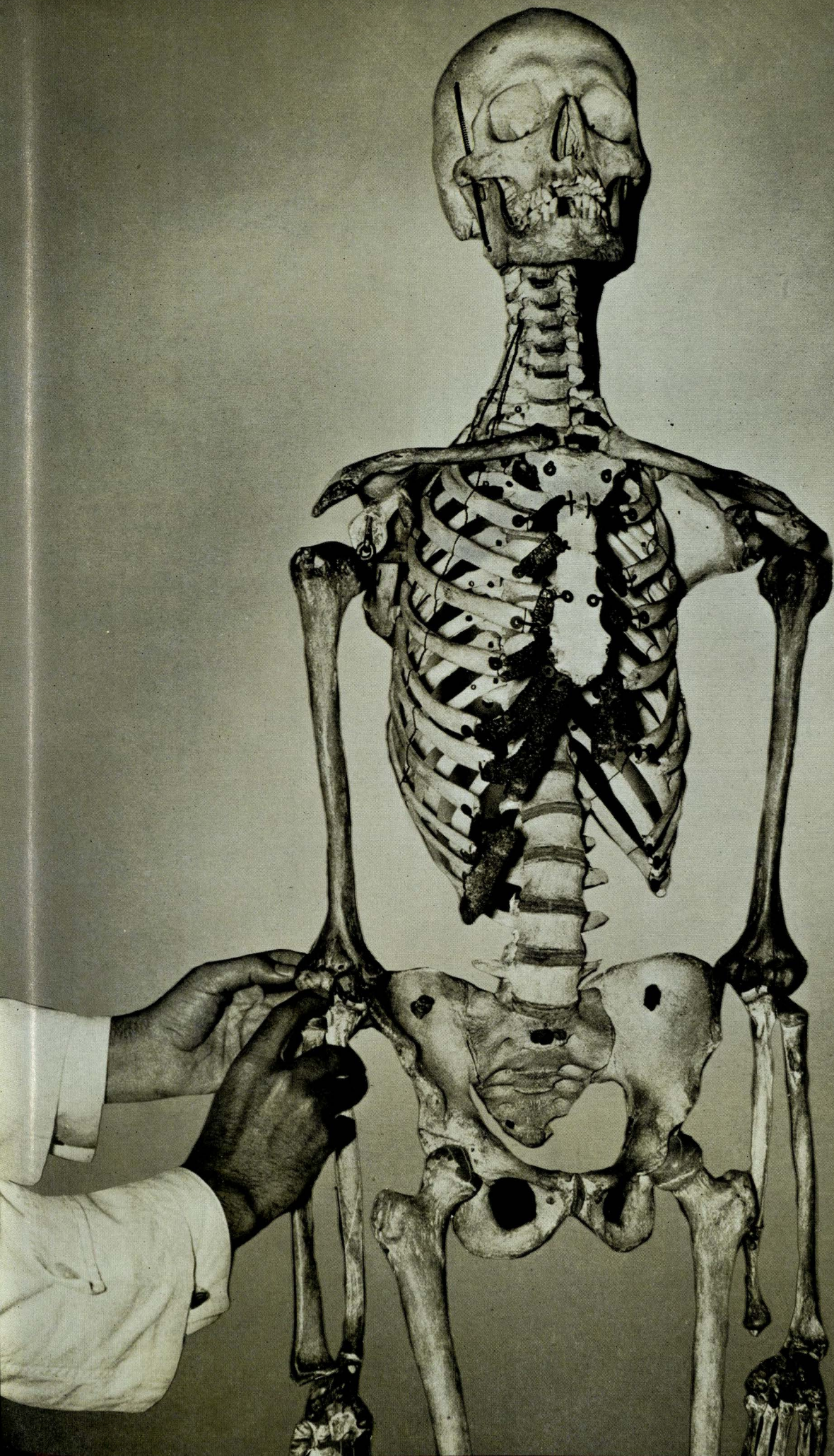



Edmond Abdallah



Yahya Abul-Fadel



Miss Solange Abu-Nassar



David Albina



Samir Abu-Rustum



Sami Ahmad Amr



Sahag Baghdassarian

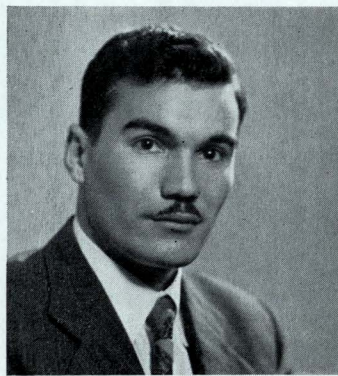

Munir Bisharah



Zaven H. Chakmakjian

Isam Dajani

Vasken Der Kaloustian

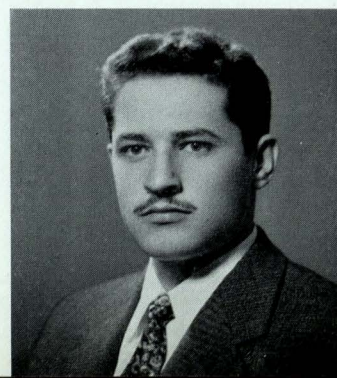

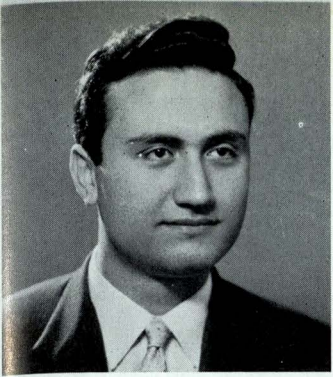

John Giragos



Shawki Gharizi



Amin Haddad

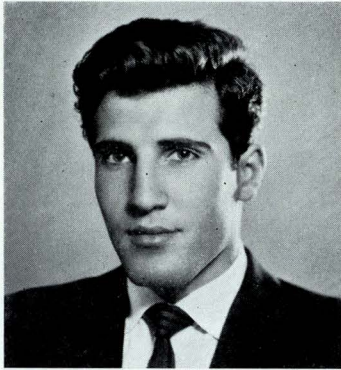

Khaldun Jajah



Senekerim Jamgotchian

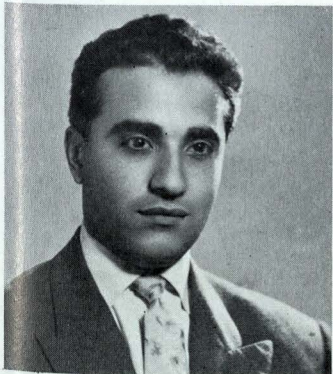

Muhammad Makki



Said Jannun



Jim Karam



Vahe Kilejian



Miss Nadya Najla Maluf

Anwar Masri

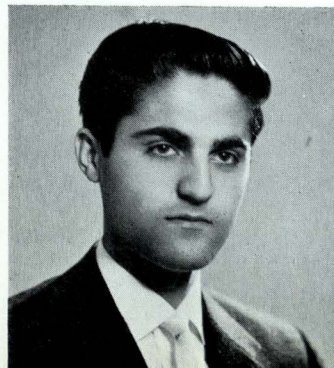

Jawdat Naffuj





Basim Rimlawi



Suad Rayyis



Naim Riwadi



Maurice Saba

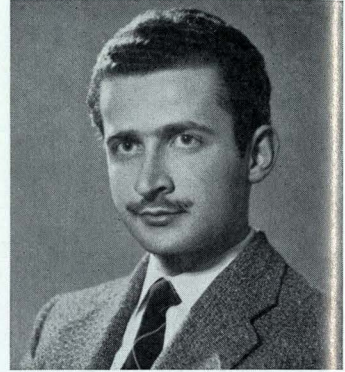

Marcel Saghir



Roger Sayigh



Ibrahim Salti

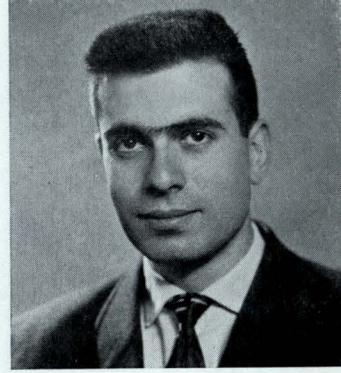

Elie Sawaya



Reuben Siraganian

Sami Shahin

Suhayl Siman



Meguerditch B. Sossoyan





Miss Nabilah Wahbah



Sarkis Zarikian



George al-Wirr

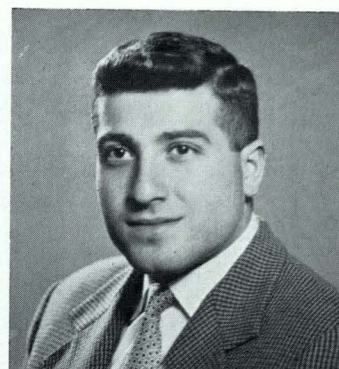

Samir Suruji

THE BEGINNING

In the year Nineteen Hundred and Fifty Eight, in the month of October, a heterogeneous sample of elements were brought together for unknown reasons. This Sample contained all the different imaginable compounds and elements, from the most precious to the most common. It was odorless, would not conduct an electric current and had no definite form. However, further investigation showed that it had the interesting property of having LIFE. Never in the history of mankind had such a discovery been made, but at the same time its dangers seemed to be great. Till now this Sample has not been reproducing, but some eminent scientists fear that it will not be long before it starts to multiply. These men think that once it takes this course, nothing will prevent it from destroying anything in its path. They are the first to be destroyed since they have been conducting research on the Sample and are closest to it.

So far four scientists and their coworkers have been studying this Sample intensely. Two of them did most of their work during the first part of the year, but the results they got were not encouraging at all. They concluded that the Sample could not be dissected to be studied and it had no tissues which were stainable with PAS and Luxol Fast Blue.* However, electron microscopic studies have disclosed that the Sample is made up of 40 different masses. These seem to be distinct entities, although sometimes they interact with each other.

* C. N. S stains

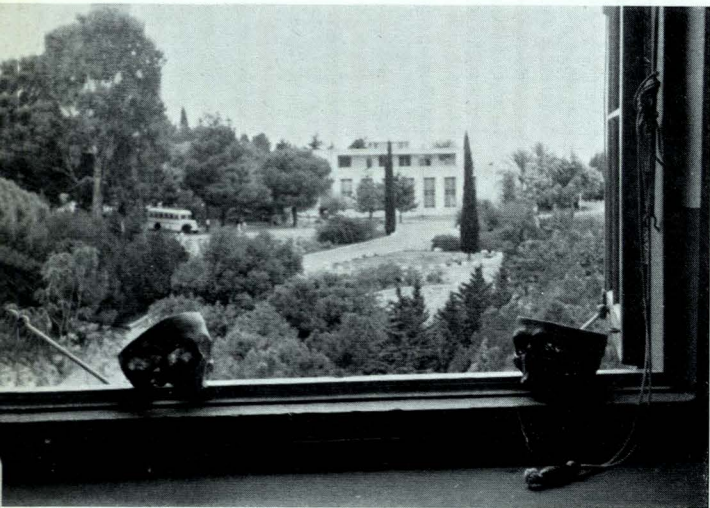

Old golden days.

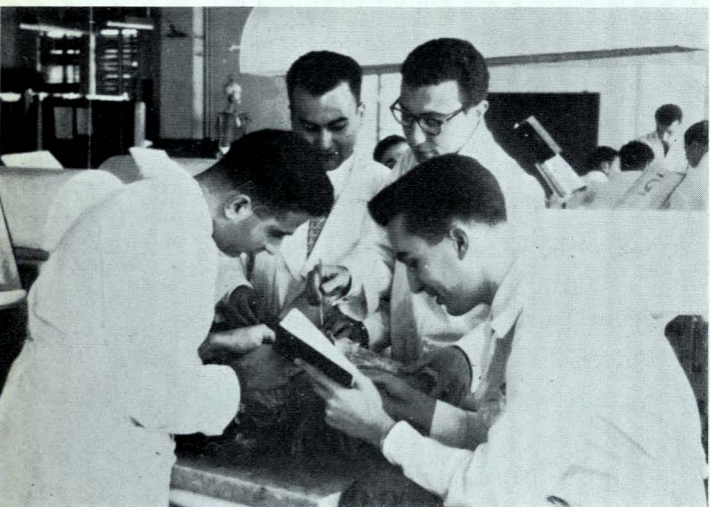

Anatomy lab.



10 : 25.

The two other scientist and their helpers have started studying the Sample after the first two gave up their efforts. As the former have not been long at their work they have not given their verdict yet. One of the extensive studies has shown, however, that inheritance in the Sample is not transmitted through DNA but by some other haphazard way which has never been encountered before.

An important fact which has just been learnt about the Sample is that everyone of the different constituents has a special system of recording things. Some recordings of their memoirs have been recently uncovered and decoded after a long and tedious research. Many speak of the tortures inflicted upon them by the scientists trying to study the Sample. Here are some lamentations :

— “Poor fellow, just think, he thought that his traditional imprisonment in a dark, cold, unventilated room could tame us. From the first time he wanted to study us, he would take from one of his pockets a funny ‘timer’, look at it, fix his feet well in the ground, wave his spear and descend upon us with “Skin, superficial fascia, Platysma, investing fascia. Keep that slide Mr. Tilkian.”

— “Oh ! He did it a thousand times with ‘Over here, over there..’ I know his aim was to

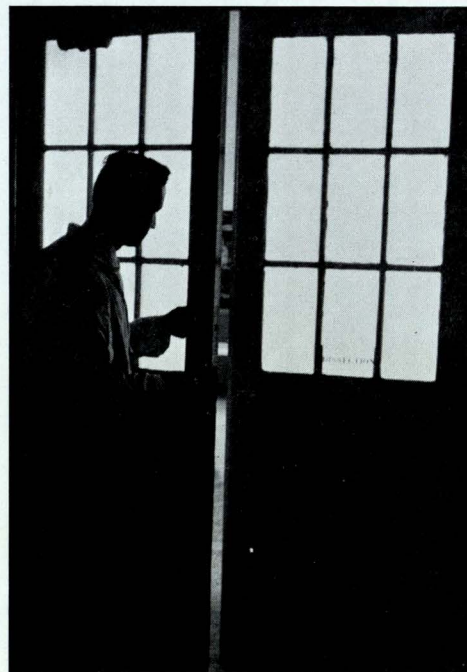

Drowsy and drunk.

incubate us. Well, under those circumstances you could not help dozing off for just a few seconds now and then, especially if you were sitting towards the back of the room. However, you were sure to wake up when the fresh air would signal that the attack was over. ”

— “Keep it between you and me, brother, we used to delay his second attack, launched in the Lab, till 10:25. ”

— “Gentlemen, first you have to smell it, then to taste it, and then to put your finger and feel it, to appreciate the real importance of what I am saying. If you don't then you will never see it again in your life. ’ ”

— “Slide 86 holds your destiny, if you identify every tissue in it you will then be a histeriologist. ”

— “Staining us with Luxol Fast Blue was not easy especially when we did not have any neurons for the synapsing of reflexes left to be stained. However, after a lot of labor some of our major points were emphasized ; at least so they say. ”

— “Where is the Triple response ? Gone with the three day midyear vacation. ”

— “What is the significance of Biostatistics ? Special lectures on how to be very serious in class. ”

— “Major Premise : We are here to teach you, not to coerce you to study.

Minor Premise : If you do not study you will fail.

Conclusion : Teaching = Coercion. ”

— “It seems that the scientists had a big bet between themselves on which one of them would be able to destroy us. But, ah ! We have been too clever for them. ”

— “So far so good, and the rest only the future can show. ”

On all the different masses there is a common inscription which after great difficulty was found to read “Medicine I, 1958-59”. We are truly a ‘heterogeneous sample’, but we are still a unity in being one class, and in being able to remember this year as the year which marked a turning point in our lives, the year we entered Medical School.

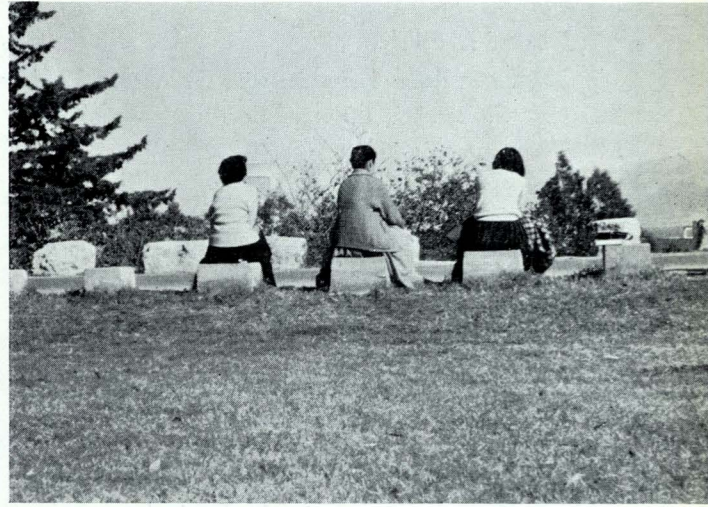

Tripple response.

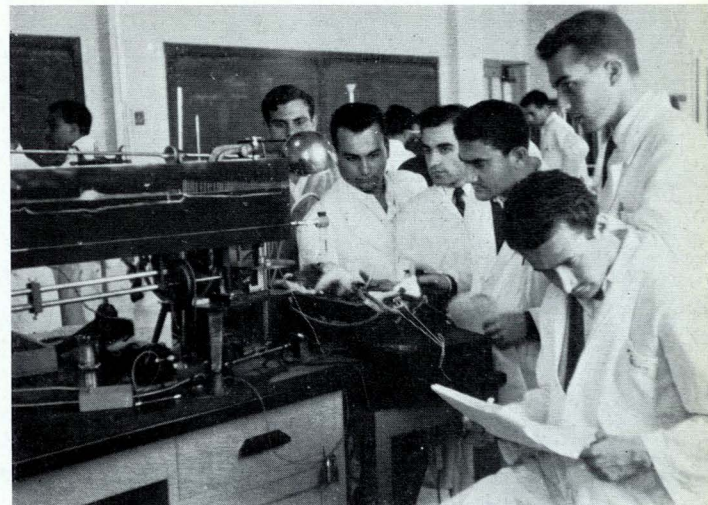

Physiology Lab.

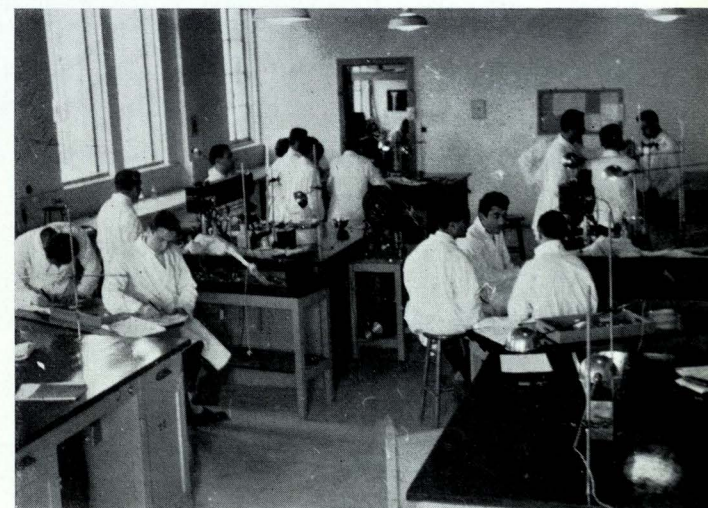

Poor Animals.

Edmond Abdallah.

Latest theory : dispense with the heart as the plasma proteins can keep the blood circulating indefinitely.

Yahya Abul-Fadl.

Deep in medicine you will find philosophy. I can't see why.

Solange Abu-Nassar.

Great hopes for paradise.

Samir Abu-Rustum.

Give me a bone cutter, chisel and a hammer,
I will cure those loud voices for ever.

David Albina.

Negative bathmotropic properties on earth. In the Moon??

Ahmad Amr.

Nervous system : Low threshold.
Vocal System : High intensity.

Sahag Baghdassarian.

A special medical excuse for two days before a quiz.

Munir Bisharah.

"Doctors can find time to do anything they like ; even to wash their gowns."

Zaven H. Chakmakjian.

Symptoms : $1/2$ the time silent + $1/2$ the time quiet.
Diagnosis : paralyzed vocal cords.
Prognosis : Authorities differ.

Isam Dajani.

Red Riding Hood . . . in class.

Vazken Der Kaloustian.

A raincoat + a hat + a bag = class diplomat.

Shawki Gharizi.

By midyear he changed his title from visiting student to stranger in Van Dyck.

John Giragos.

"Medicine to me is a branch of psychology."

Amin Haddad.

Entering class late is an art which he has beautifully mastered.

Khaldun Jajah.

"Medical School is somewhat like a basket-ball game ; you sometimes win and sometimes lose."

Senekerim Jamgotchian.

A coat, two sweaters, a lump of hair.
I'm warm all winter ; what do I care ?

Said Jannun.

Always around in a hurry, busy, doing exactly nothing.

Jim Karam.

Jim's Jamieson jammed.

Vahé O. Kilejian.

From Epicureanism that youth and health inspire.
To the Stoicism Medicine and Prof's require.

Muhammad Makki.

The new librarian.

Nadya Najla Maluf :

Patient : I am a medical student. I have 39.9°C temperature ; jaundice, tachycardia, loss of weight...

Dr. Maluf : Yes, yes. Did you have a 5 minute quiz ?

Abdur-Rahim Malhas.

Stage manager — lights section — for Medicine I.

Anwar Masri.

"Oh ! Gone are the good old days when I was a Freshman and we planted lettuce under the windows back home."

Jawdat Naffuj.

Life is but a moving shadow on a tennis court.

Suad Rayyis.

Oh, no ! You don't say. That is precisely sensational.

Basim Rimlawi.

Sir, this vein is Jamieson, I read it in Jugular, The nerve supply of Hamilton is not written in Hamstrings.

Naim Riwadi.

Si vous revisez l'anatomie chaque fois que vous dansez, bientôt vous pourrez l'enseigner au professeur Ghantus.

Maurice Saba.

Arguing is an art which needs a lot of patience, especially when the argument is with the teacher.

Marcel Saghir.

2 elegant + 2 tame + transparent figure = Anatomy specimen par excellence.

Ibrahim Salti.

Slow waters run deep.

Elie Sawaya.

When stained with Mallory-azan will give excellent idea of what stratified columnar cells look like.

Roger Sayigh :

Science in the left pocket, religion in the right, himself in between.

Sami Shahin.

To be discussed later in more details ; i.e. during the clinical years.

Suhayl Siman.

By mornings I swallow stopwatches to keep probing questions, By evenings I cram a bit, is that a sin ?

Reuben Siraganian.

"What's difficult about the material. I think it is very easy."

Meguerditch B. Sossoyan.

Ahh ! Me tough guy, Me Tarzan Me can swim good, me big man.

Samir Suruji.

Dissecting in anatomy Lab.

"Holo lo lo Holo lo lo,

This is Medical Rock n' Rolo."

Nabilah Wahbah.

Easy goes, easy comes.

George Al-Wirr.

A cut I'd like from time to time.

I like to sleep. Is that a crime ?

Sarkis Zarikian.

The only important thing to remember is that the Subclavian artery finally goes to the arm, the rest...

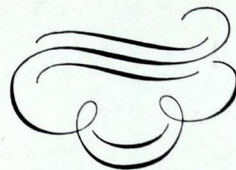

PHOTOGRAPHIC WITCHCRAFT.

WITCH - SOUREN.



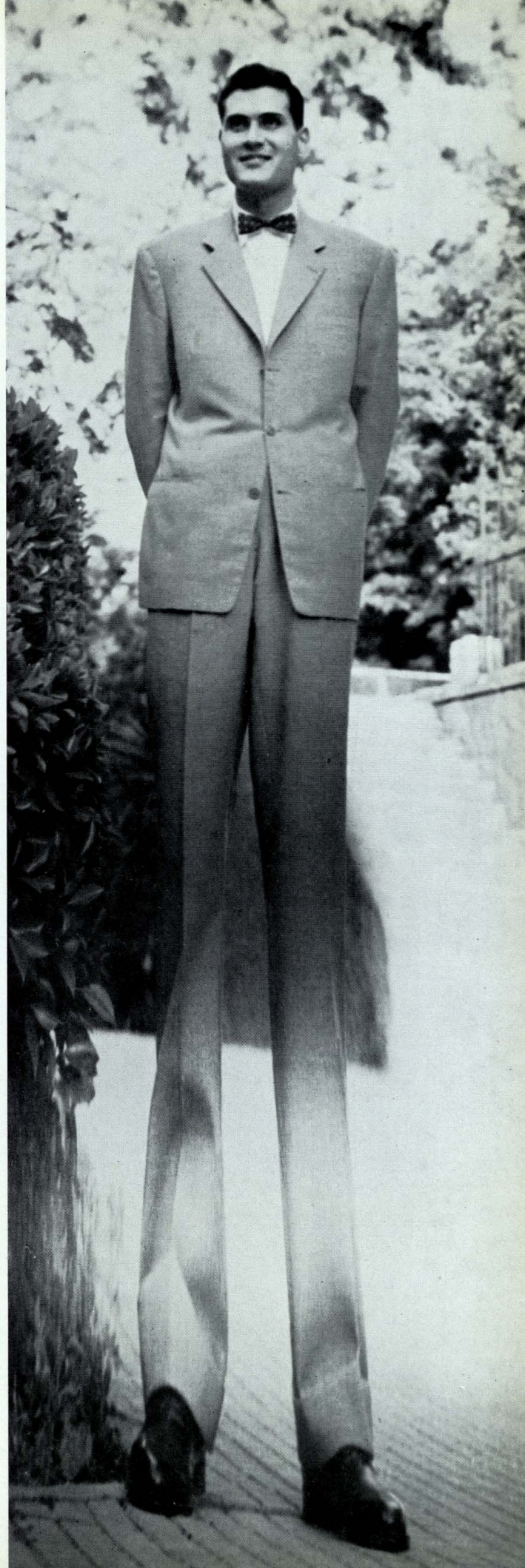
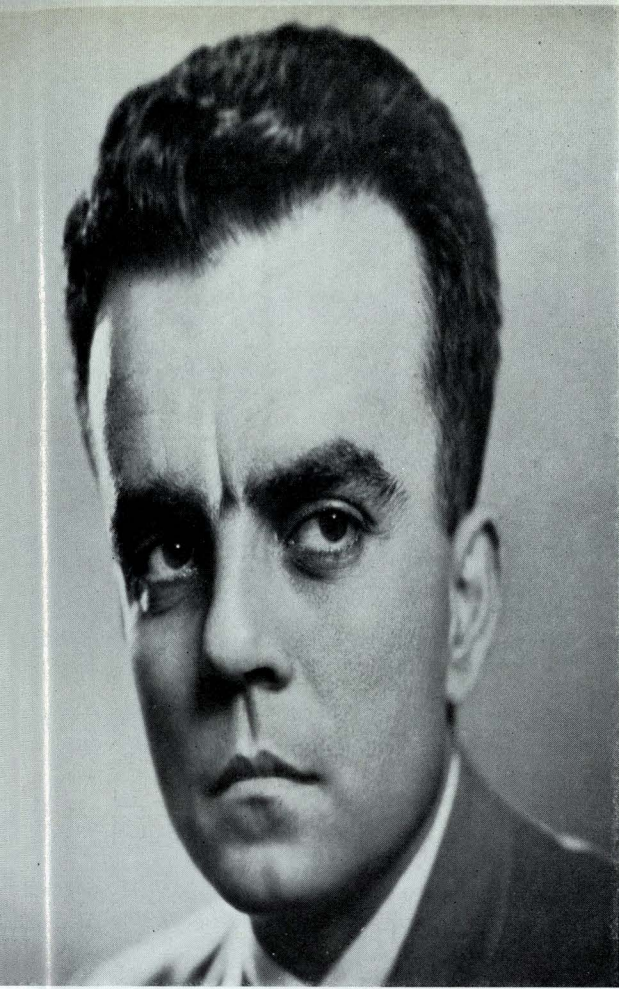

A
C
T
I
V
I
T
I
E
S





FROM OUR M.S.S. ADVISER.

Dear Friends :

Although I meet and talk to many of you daily, I take this opportunity of saying to *all* of you, via the yearbook, how much I have enjoyed working with you, not only in the classroom and Hospital, but, in the Medical Students' Society. Also allow me to congratulate you on your accomplishments, both academic and extra-curricular, during the past year. May you continue to be diligent, serious, worthy of confidence and true to all the traditions of this noble profession you have chosen for your life work. Absolute integrity, intense scientific curiosity, maturity, humanity, invariably doing more than would ordinarily be expected of you, are some of the qualities that include doctors among the "men and classes of men who rise above the the common herd".

My best wishes for a successful career in the Service of others and may you continue to be an honor to the profession.

Sincerely,

Alfred Diab

ALFRED E. DIAB, M. D.

M. S. S. CABINET



Seated Lt. to Rt. : Haroutune Babigian. (Vice president), Raja N. Khuri (President), Adnan Dajani (Treasurer).

Standing Lt. to Rt. : Hisham Majdhub, Maurice Yuwakim, Samir Abu-Rustum (Members), Garbis Eknayan (Secretary), Amin T. Nasr (Member).

Dr. Howard Mitchell, AOA Indiana
1949, Speaker during the annual instal-
lation banquet.



ALPHA
OMEGA
ALPHA

The annual installation banquet.



A. U. B. Alpha Omega Alpha Chapter Members.





M. S. S. CREATIONS

Many of the M. S. S. activities are traditional. This year a number of novelties were introduced to the list of traditions. In the few following pages you can have a glimpse at these achievements.



S. A. S. Ghazanfar receiving the M. S. S. Research Fellowship award from Dr. Calvin Schwabe.

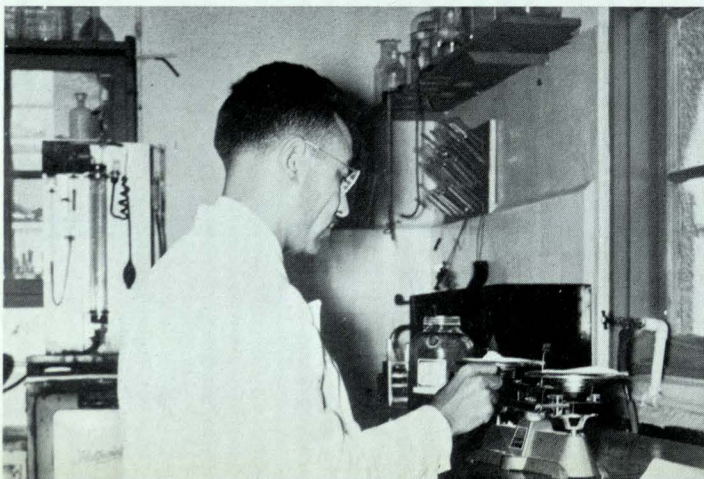

Ghazanfar and the Balance be bought with the award money.

M. S. S. COOPERATIVE

This committee was formed to help supply — within certain limits and at reasonable prices — the students' needs of new and second hand textbooks, instruments, and gowns.

The Blazers, which became so prominent an object of attire on the campus were supplied by this Committee and more than 60 were made.

Also, thanks to the committee, MSS pennants are displayed on all official functions of the Society as well as in homes and cars.



The blazers.



The first M. S. S. pennant presented to Dr. J. J. McDonald.

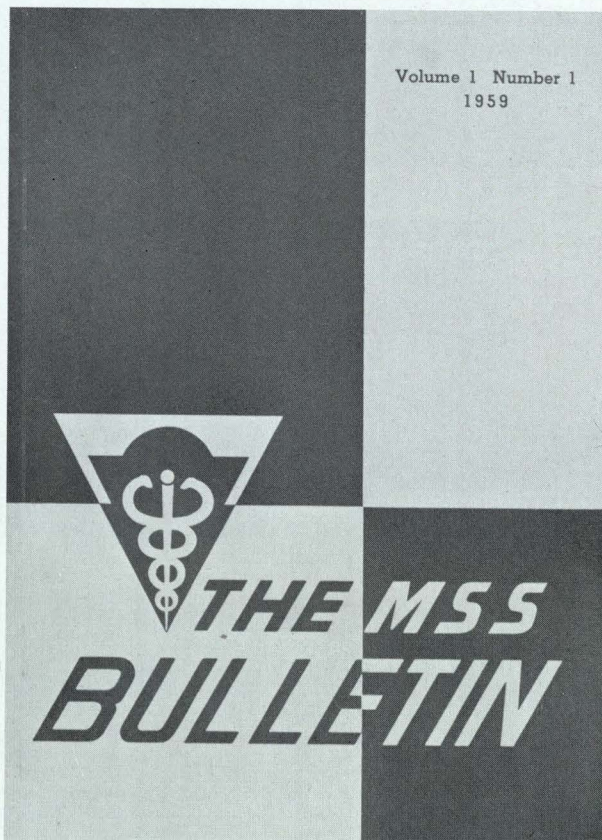

M. S. S. BULLETIN



Cabinet members receiving guests.



First Yearers receiving the M. S. S. pins from Dr. A. Diab (Adviser).



One of the 31 teams of the Megalos Adelpbos system.

THE MEGALOS ADELPHOS SYSTEM

On October 24, 1958, in the atmosphere of a friendly gathering of medical students and faculty, a new advisorship system was launched. This system is known as the Megalos Adelpbos System and its organization is based on seniority wherein junior students come into association with their senior colleagues. In the encounter of a junior student with his senior two desirable values are expected to be realized. These are Guidance and Brotherhood.

The students of our Medical School are divided into 31 teams ; each team consisting of 6 students, one or more from each of the 5 classes. The fourth and fifth year students are the seniors of the team. Each team has a guardian from the medical faculty. The students, both as a team and individually, may seek the advice and help of their guardians. In spite of the adoption of the team arrangement, the emphasis is on individual contact within the framework of the team, rather than on group action.



President R. N. Khuri presenting the M. S. S. pennant to Dr. A. Diab.

M. S. S. BAND



The start : a small nucleus.



Dreamy Jimmy !



Jean Jack beating the slow rhythm.



Apprentice drummer.



That's the real work.



M. S. S. RECREATIONS

The M. S. S. was active in all fields during this year, everything was done with conviction and zeal. Let us go back and remember some of the activities that took place during this scholastic year.

ANNIVERSARY



Umpire — Dean J. J. McDonald.



Raja N. Khuri.

STUDENTS Vs. FACULTY

Dr. Fuad Sabra.





Zer eiz a vouman on zee campous who vokes like zees.

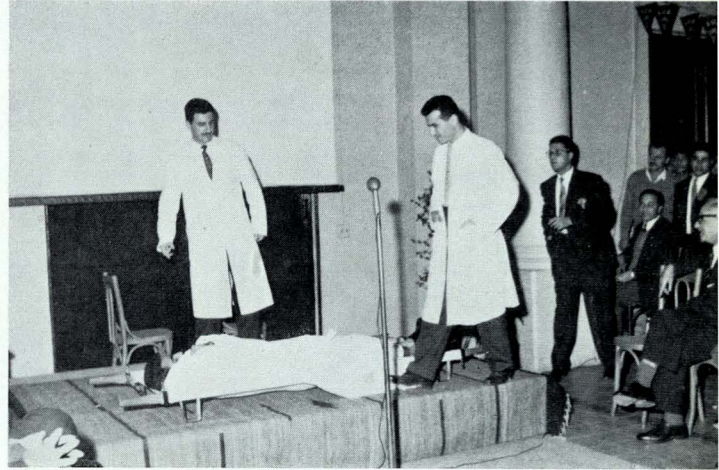

“ Give him anything Farid, just anything ”.



When the Gods from the world of shadows meet.



Emile and the boys.



شو قاتلك أنا - شو

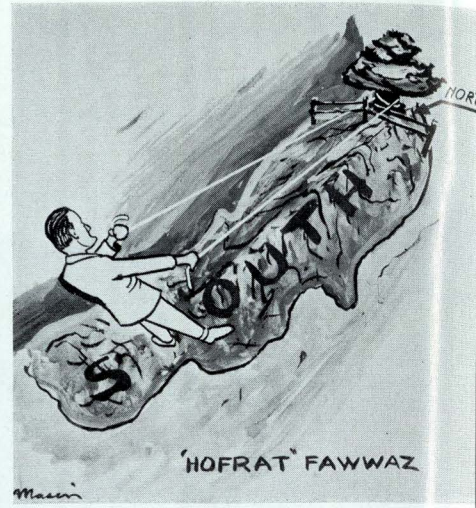



Encore Emile.

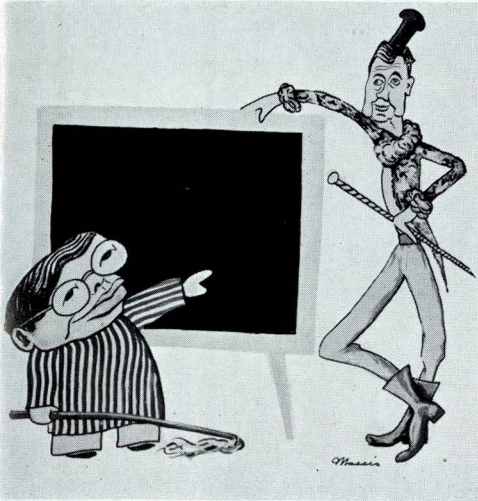

Mrs. Leonard cutting the Anniversary cake.



Dr. Nasif receiving the M. S. S. Service medal.



Hello there.



President Leonard drawing the lucky number.

*
BALLS AND PARTIES
*



A jolly atmosphere.



"Around the space with M. S. S."



Hurry up boys.



Prof. and their wives during the 1st Yearers' welcoming party at Dale Home.

Glimpses from the W.S.O. and M.S.S. joint party at West Hall.





Music hour at O.P.D.



كان كل شيء على ما يرام الى ان وقع ما لم يكن في الحسبان ، عندما تلقت دوائر استخبارات أمن الدولة والتابعة لمكاتب الجيش برئاسة العسكرية حامل اختام السلطان الصدر مدحت برنارد افندي اسحق ، خبراً مفاده نشوب ثورة في مقاطعة ازمير عداها جحافل من الفئران المتمرنة على القتال . فكان من مجلس أمن الدولة ان انتدب العبد الفقير المفتقر الى رحمة ربه والناكر لنعمة العسكرية عسكر أراضان كريس بك ايكنويان قائد السرية العاشرة من الجيش الانكشاري والحيمة في هضاب الانضول . وجرياً مع التقاليد العثمانية وجهت العسكرية عسكر كريس بك للمشول امام جلالة مولانا المعظم ، حيث وهبه قيادة الحملة . وقبل بدء المعركة المسماة العثمانية - الجرذانية ، طير العسكرية رسالته التالية الى جلالة مولانا :

« يا سيدي ومولاي الذي ودادي له واعتمادي عليه وامتدادي منه ان وهبتي اعزك الله لباس نعمتك ، ألا وان الحرب كر وفر ، فلا غرو ان يغص بالماء شاربـه ويقتل بالدواء المستشفي به ، ويؤتى الحذر من مأمنه ، وتكون منية المتمني في امنيته ، والحين قد يسبق جهد الحريص » .

لقد جرت معركة حامية الوطيس مع الجرذان ، ولكن قد غص بالماء شاربـه وقتل بالدواء المستشفي به وسبق الجهد الحريص ، فسقط قتيلاً حياة المرحوم والمأسوف على شبابه ارضان كريس بك . شيع جثمانه بموكب ضخم ، وصلى عليه سماحة الشيخ ومفتي الولاية زين العابدين رياض طه ابو العيون ، وأودع الجثمان في قبر بالقرب من مأوى العجزة . فانّا لله واليه راجعون فلا حول ولا قوة الا بالله العلي العظيم .

والسلام عليكم .

الامضاء الوالي :

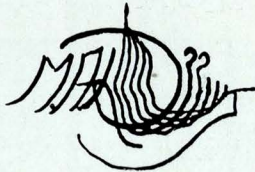

جعفر بن زيد معروف بك الرزوق

في ١٤ جمادي الاول ١٩٩٩ هـ



مدير التشريفات ممدوح اميل سرناج بك ديج



رئيس اغوات القصر ابو الهدى محمود نجم شوكت آغا النت



الباور ابو الظوظ شريف يعقوب بك عمر

بسم الله الرحمن الرحيم :

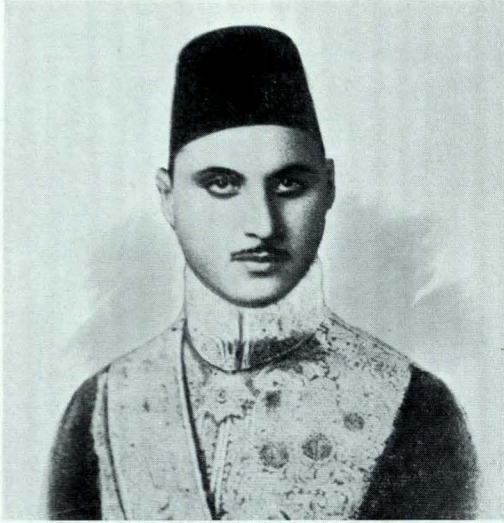

خازن الدولة آغوب وهي باشا شعيب

فبحقك بارك مولانا السلطان المعظم ، والخاص الاعظم
أمير المؤمنين وخليفة المؤبدن (مشتقة من O. P. D.) ،
سيدنا الغازي ابن الغازي ، الخان عبد الحميد فايز سويدان ،
خاقان البحرين وخدام الحرمين الشريفين ، أعز الله سلطنته ،
وحرس بهجته ومهجته . أما وبعد فان جلالته قد اعتلى
كرسي السلطنة منذ نيف ، كخليفة للخان عبد الحميد سمير
الحج . وقبل سفره الى اميركا فان جلالة مولانا ، قد عهد
بشؤون السلطنة لولي العهد الخان الغازي ابن الغازي سمير
محمد رشاد شحادي ، النبيل ابن النبيل ، صاحب الأصل
العظيم والملك الطويل وسليل آل أرطغرول . ان سموه
حالياً يتلقى علومه في جامعة الاستانة على يد كبار علماء
الدين ورجال الفقه المتضلعين .



الصدر الاعظم مدحت برنارد افندي اسحق

ان جلالة مولانا السلطان قد انعم عليّ بمقاليد الحكم
ومنجني جميل ثقته . فبالعاون مع الحاشية وعملاً بالحقوق
الممنوحة للوالي ، بموجب : الخط الهياوي وخط شريف
كولخانه جعلت من هذه المقاطعة احسن ولاية فأقمنا
العدل ... ونشرنا الرفاهية في ربوعه .. وبنينا خالص
المودة مع ولاية « الديل هوم » ، وبدأنا التمثيل الدبلوماسي
مع ولاية صربية واميرها الشيخ حسن مارديل . فعينت
بمرسوم ملكي كقنصل أول سعادة وزير المال وخازن
الدولة آغوب وهي باشا شعيب . فكان ما كان من نشاطه
ان فرض الجزية على الشيخ حسن مارديل . فأخذت لذائد
الخلوى الرقيقة القشر الكثيفة الحشو اللؤلؤية اللون ، والتي
هي اجرى في الخلق وامضى في العروق تتوارد الى الملكة .
ايام وشهور وليال عاطرات ملؤها الافراح والاهازيج
وحفلات السمر التي كان يقوم بتنظيمها مدير تشريفات القصر
الملكى بمدوح اميل سرنج بك دبيج ، مؤلف « كتاب خلق
الافراح وبعثرة الاتراح ، في ديار مبغضي السهو وطلاب
اللهو » . كان ينظمها بالاشتراك مع الياور ابو الطوظ شريف
يعقوب بك عمر ، الممثل الدراماتيكي العنيف والحائز على
شهادة التمثيل المسرحي من معاهد الفن في قرطبة وطليلة
وقرطاجنة ، والمتتمرن على يد رئيس اغوات القصر والخدمشية
ابو الهدى محمود نجم شوكت آغا التن ، خريج معهد ابو
النواس في شرب الخمر وتعليم المهعنة في اصول علم الزعرنة .

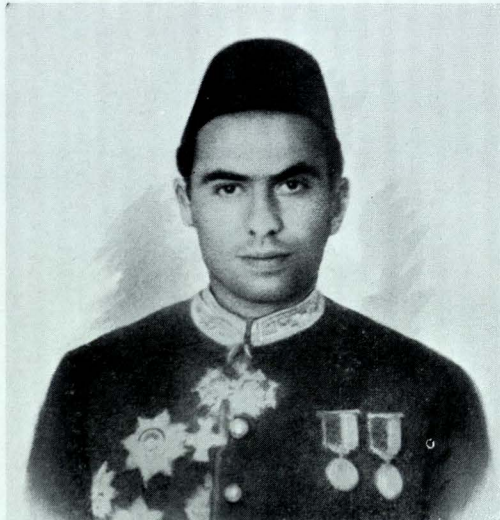

المسكرتاه عسكر ارضان كريبس بك ايكنويان



خاقان البحرين الخان عبد الحميد فايز سويدان



الوالي جعفر بن زيد معروف بك الرزوق

خطاب العرش
النسيبي



ولي العهد الغازي سمير محمد رشاد شحادي

T R I P S



Preparing to come back from cedars.



Chit-chat on the road.



Having fun among the tall pine trees.



Picnicking.



A smoke.... and a joke !!

Living up for a picture in one of the many trips.





Boys ... and girls !!



Having a riot of a time ?



Oley Mexicano.



Satisfying a big appetite.



Behold the mountains of the Lebanon



Launch trip to Ma'amaltein



When warm, start by dipping the toes.



The look in his eye, the set of his arms
 a champion

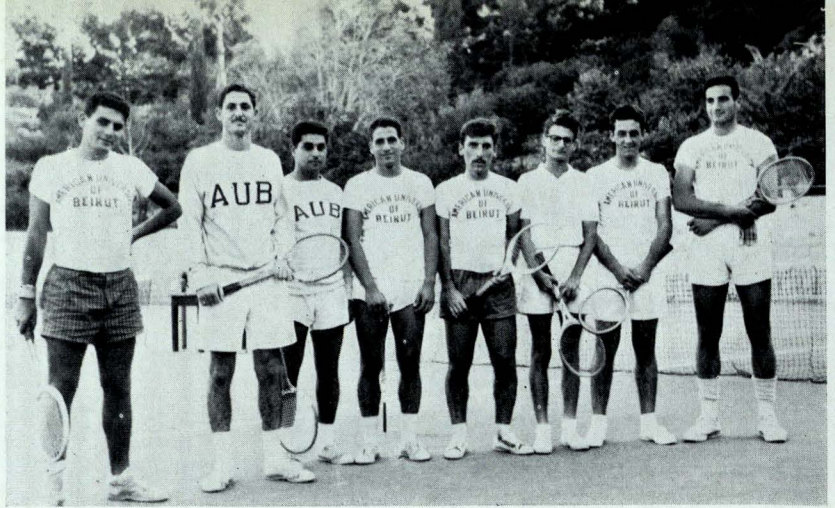

Engineering Vs. Medicine.

SPORTS



The first by a nose, guess who knows.



On the field.



Our "invincible" (Ahem !) football team.



In basketball we stand well.



President Leonard congratulates Alex Zacharia a champion.



Une félicitation en plus ! one more trophy.

An all round

. athlete.

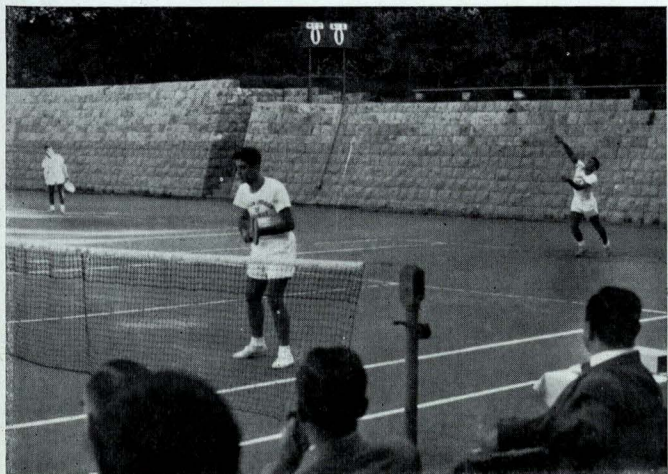

With Shafic at the net, no balls pass by !



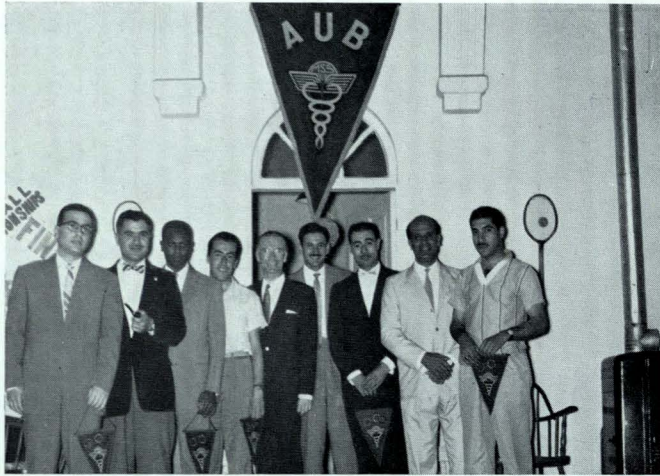

Honouring the athletes.



Abraha Tedla receiving his olympic pennant



Dr. Ra'if Nassif receiving the M. S. S. Olympic pennant from Dean McDonald.
Mr. Tarabulsi on the right.



Every one



.... gets refreshments.

MISCELLANEOUS



Medical students do their share in the MEMA.



Before a lecture during the MEMA.



Uncovering the plaque which commemorates the gift of Mrs. Aziz Khoury to the E. E. N. T. dep't.



"Spraachen Zie Deutch?" "Ja".
"Droppen Zie Dead".

FROM THE EDITOR

Four years ago a group of Medical Students decided to start the "Caduceus". They were fully aware of their inexperience and of the difficulties of the job, so they set a motto which became their ultimate goal: "To have a better yearbook every year". For few years the students learned from their own mistakes but they worked hard and produced an original yearbook every year.

We hope that you will look at this yearbook with a critical eye and decide if this year too we were successful in keeping our motto.

On behalf of the Caduceus Editorial Board I would like to extend our thanks to Dean J. J. McDonald for helping us in some technical fields and to Dr. Alfred Diab for keeping an eye on and helping us in all the activities of the M.S.S.

Also I would like to thank our Photographer Souren and the printers Dar-Al-Ahad who sacrificed all personal and financial gains in order to help us produce a worthy book.

We owe a great deal to Misses Georgette Rizk and Alice Karakashian for typing all the manuscripts.

To our advertisers, we extend our gratitude and we hope that this yearbook will prove worthy of the money they put in.

I would also like to congratulate the Caduceus Staff for their unified stand and effort even in front of some impossible situations which they were able to overcome and attain their goal.

From here we hand the task of the 1960 yearbook to the coming group of students and wish them the best of luck.

HAROUTUNE BABIGIAN

Editor.

AD - DEX

Index

- ABDALLAH, Edmond b. 1935, Baslookit, Lebanon. Lebanese. *Class of '63* (p. 94).
- ABDULIAN, Misak b. 1934, Kassab, Syria. U. A. R. *Class of '62* (p. 89).
- ABDUL NOUR, Alice, Br. Guiana, S. America. British. M. D. 1956 Royal College of Surgeons, Dublin, Ireland. *Assistant Resident in Pediatrics* (p. 35).
- ABRAHA, Isaac b. 1932, Asmara, Eritrea. Ethiopian. *Class of '62* (p. 91).
- ABUCHDID, Adma E. b. 1904, Sao Paolo, Brazil. Lebanese. M.D. '31, A.U.B. *Associate Clinical Professor of Obs. and Gyn.* (p. 32).
- ABU HAIDAR, George I, b. 1918, Khartum, Sudan. Lebanese. M. A. '47, A. U. B. *Instructor in Biochemistry* (p. 39).
- ABU HAIDAR, Najib b. 1923, Hammana, Lebanon. Lebanese. M.D. '48, A.U.B. *Assistant Professor of Internal Medicine* (p. 26).
- ABU JAWDEH, Caesar N. b. 1920, Jaffa, Palestine. Lebanese M. D. '44, A. U. B. F. A. C. S., *Assistant Clinical Professor of Ophthalmology and Otolaryngology* (on leave).
- ABU KURAH, Abdurrazzak b. 1936, Amman, Jordan. Jordanian. *Class of '62* (p. 91).
- ABUL-FADL, Yahya b. 1935, Sweida, Syria U. A. R. *Class of '63* (p. 94).
- ABU-NASSAR, Solange b. 1936, Haifa, Palestine. Palestinian. *Class of '63* (p. 94).
- ABU-RUSTUM, Samir b. 1939, Tripoli, Lebanon. Lebanese. *Class of '63* (p. 94, 107).
- ABUL-HUSN, Najiba b. 1936, Lebanese. *Class of '62* (p. 88).
- ABUL-DHAHAB, Faruk S. b. 1932, Mreyjat, Lebanon. Lebanese. *Class of '59* (p. 48, 57).
- ADHAM, Nabil F. b. 1933, Beirut, Lebanon. Lebanese. *Class of '60* (p. 64).
- AJANS, Zaki A. b. 1936, Aleppo, Syria. U. A. R. *Class of '61* (p. 74-83).
- ALBINI, David b. 1937, Jerusalem, Palestine. Palestinian. *Class of '63* (p. 94).
- AMARF, Mammo b. 1935, Addis Ababa, Ethiopia. Ethiopian. *Class of '61* (p. 74-83).
- AMR, Ahmad Sami b. 1936, Hebron, Palestine. Jordanian. *Class of '63* (p. 94).

(Contd. on page 137)

NEW, IMPORTANT DEVELOPMENT IMPROVED TRICOFURON
VAGINAL SUPPOSITORIES AND POWDER

*Now contain a new specific
fungicide*

MICOFUR

BRAND OF NIFUROXIME

*in addition to the established
specific trichomonacide*

FUROXONE

BRAND OF FURAZOLIDONE

FOR THE TREATMENT OF VAGINITIS CAUSED BY MONILIA, TRICHOMONAS OR HAEMOPHILUS VAGINALIS

**IN GENITOURINARY
TRACT INFECTIONS...**

DELAY IS DANGEROUS

FURADANTIN[®]

BRAND OF NITROFURANTOIN

first...
for rapid eradication of infection

FIRST BECAUSE OF THESE ADVANTAGES

- a specific for genitourinary tract infections
- rapid bactericidal action against a wide range of gram-positive and gram-negative bacteria and organisms resistant to other agents including Proteus and certain strains of Pseudomonas
- negligible development of bacterial resistance after 5 years of extensive use
- excellent tolerance—nontoxic to kidneys, liver and blood-forming organs. No cases of monilial superinfection, crystalluria or staphylococcal enteritis ever reported
- safe for use in pregnancy

AVERAGE FURADANTIN DOSAGE

TABLETS : Acute complicated, refractory or chronic urinary tract infections — Adults : four 100 mg. tablets daily; 1 tablet with each meal and 1 with food or milk on retiring. Continue for 3 days after urine becomes sterile.

Acute uncomplicated urinary tract infections -

Adults : four 50 mg. tablets daily. If patient is unresponsive after 2 or 3 days, increase dose to 100 mg. q.i.d.

Prostatitis — Acute cases : four 100 mg. tablets daily until cured. Chronic cases : same as above for 10 to 14 days ; depending on response, dosage may then be reduced to 100 mg. or 200 mg. daily for 1 to 3 months.

SUPPLIED : tablets of 50 and 100 mg.

ORAL SUSPENSION : Adults : 4 teaspoonfuls 4 times daily, with food or milk. Children : 5 to 7 mg. per Kg. per 24 hours in divided doses with food or milk. It is readily miscible with water, infants' formulae, milk or fruit juices.

SUPPLIED : bottle of 60 cc. (25 mg. Furadantin per 5 cc. tsp.)

FURADANTIN... ONE OF THE NITROFURANS - A NEW CLASS OF ANTIMICROBIALS
PRODUCTS OF EATON RESEARCH, EATON LABORATORIES, NORWICH, NEW YORK



EATON LABORATORIES, NORWICH, NEW YORK

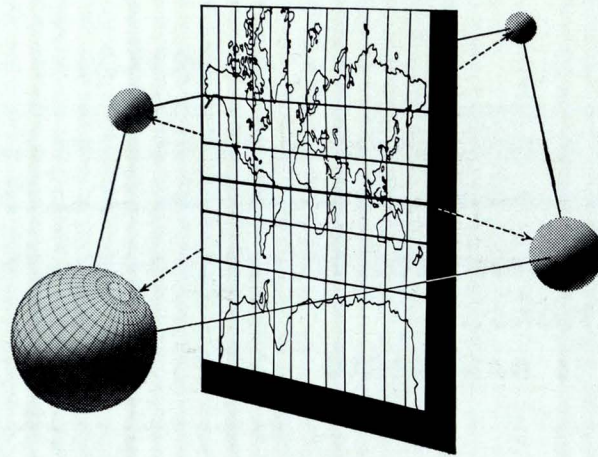

BEFORE ENTERING MEDICAL SCHOOL...

You probably never heard of Abbott

THIS WOULD not be surprising, because Abbott is an ethical pharmaceutical house. The great majority of laymen not only have never seen an Abbott ad, they've seen few if any Abbott labels—including such famous ones as Pentothal, Nembutal, Erythrocin, Vi-Daylin and Selsun.

They do not know, for example:

- ... that in nearly every country in the world Abbott is serving and supplying drugs to the medical profession.
- ... that Abbott has manufacturing plants on every continent—22 in all, with 2 new ones abuilding.
- ... that Abbott is a leader in the field of research—continually searching for new products and improving upon old ones.
- ... that its products are made with a dependability intended to deserve and hold your confidence from the beginning to the end of your medical career.

All this most laymen do not know. But you do—now.

Abbott

Power for Progress

Wherever the latent power of water is harnessed in the cause of industrial and civic development, oil, itself the world's main source of power, is playing its vital part. It provides fuels and lubricants for the machines of the dam builders; special oils and greases for the smooth, uninterrupted functioning of turbines and generators. It partners electricity in its contribution to progress.

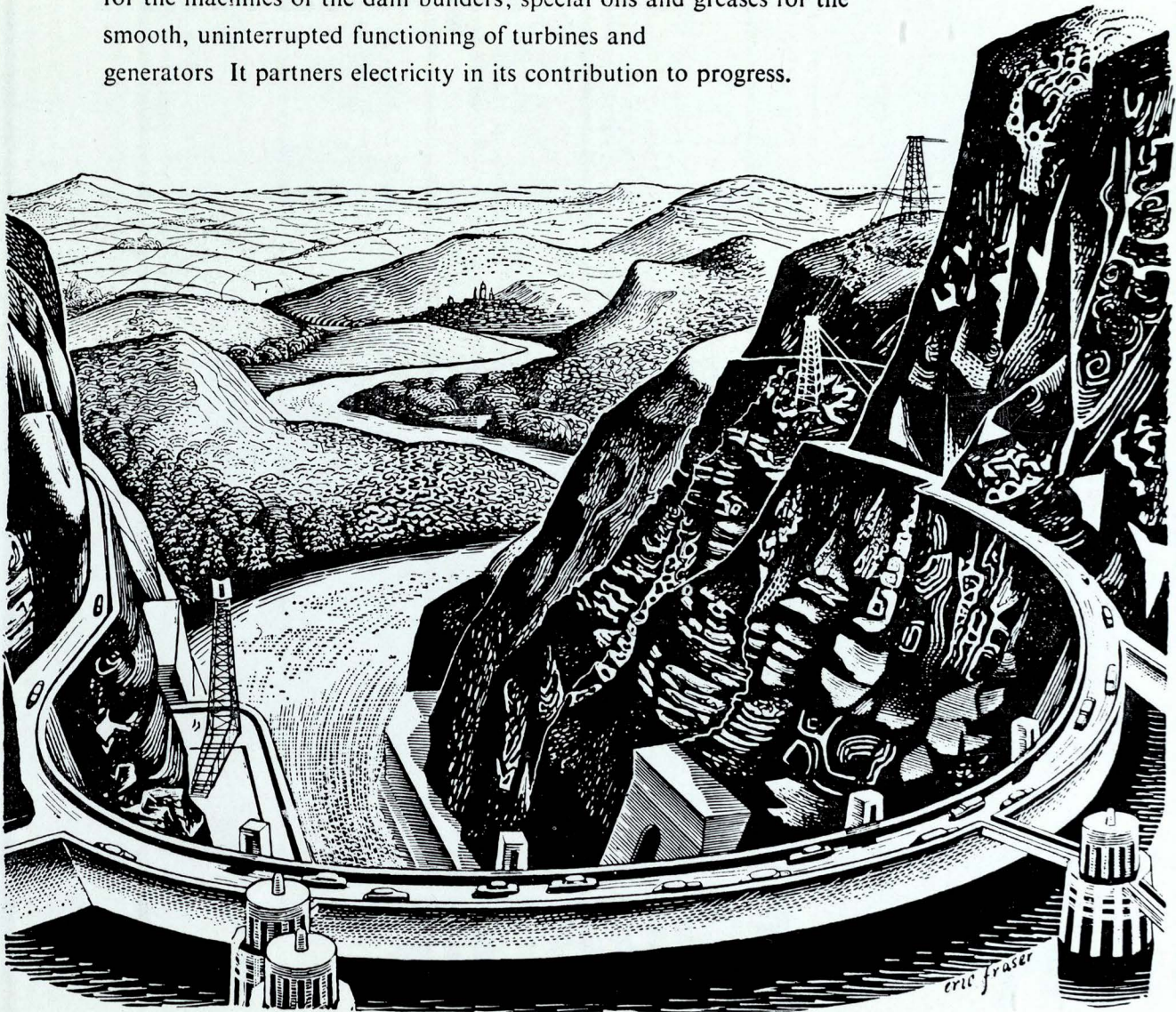

But progress is its own task master, generating new and changing demands for oil. Rich in experience, resources and skilled personnel Shell, in all its world-wide operations, is geared to the task and to the responsibility of meeting those demands.

serving progress



mental
emotional
physical

equilibrium



EQUANIL*

Meprobamate

- psychic disorders of everyday practice
- anxiety
- tension

SPARINE*

Promazine Hydrochloride

- serious psychotic disorders
- acute motor agitation

WYETH INTERNATIONAL LIMITED • Philadelphia 1, Pa., U. S. A.

*Trademark

ES-1-Eja

135



Stay youthful and vigorous
with **GRESUTON**[®]

- ANDONIAN, Barkev S. b. 1931, Aleppo, Syria U. A. R., M. D. '56, A. U. B. *Resident in Pediatrics* (p. 34).
- ANTYPAS, Philip b. 1921, Syrian, U. A. R., M. D. '48, A. U. B. *Assistant Clinical Professor of Surgery* (p. 29).
- ASFOUR, Raja Y. b. 1931, Shafa Amer, Palestine. Palestinian. M. D. '57, A. U. B. *Senior Assistant Resident in Pediatrics* (p. 34).
- ASHKAR, Fuad b. 1935, Brummana Lebanon. Lebanese. *Class of '62* (p. 86).
- ATYAH, Maurice b. 1934, Amyoun, Lebanon. Lebanese. *Class of '60* (p. 64).
- AL-ATTAR, Mundhir b. 1934, Beirut, Lebanon. Lebanese. *Class of '62* (p. 86).
- AUDEH, William b. 1929, Khartum, Sudan. Jordanian. M. D. '53, A. U. B. *Senior Assistant Resident in Surgery* (p. 29).
- AYVAZIAN, Vatché b. 1934, Beirut, Lebanon. Lebanese. *Class of '62* (p. 86).
- AZAR, Joseph E. b. 1919, Bshamoun, Lebanon. Lebanese. M. D. '46, A. U. B., D. T. M. & H., England, 1950 *Assistant Professor of Communicable Diseases* (p. 27).
- AZAR, Henry M. D. A. U. B. ; *Assistant Professor of Pathology* (p. 23).
- AZOURY, Bahij S. b. 1923 Sidon, Lebanon. Lebanese. M. D. '48, A. U. B., D. Med. Sc. 54 Columbia University. *Assistant Clinical Professor of Surgery* (p. 28).
- AZOURY, Faris J. b. 1934, Beirut, Lebanon. Lebanese. *Class of '61* (p. 74-83).
- AZOURY, Ramiz S. b. 1930, Sidon, Lebanon. Lebanese. M. D. '58, A. U. B. *Junior Assistant Resident in Surgery* (p. 30).
- BABIGIAN, Harutune M. b. 1935 Jerusalem, Palestine. Jordanian. *Class of '60* (p. 4,65,107).
- BADEER, Henry S. b. 1915, Mersin, Turkey. Lebanese. M. D. '38, A. U. B. *Associate Professor of Physiology* (p. 21).
- BAGHDASSARIAN, Aram S. b. 1901, Aintab, Turkey. Lebanese. D. D. S. '25, M. D., A. U. B. *Associate Clinical Professor of Ophthalmology and Otolaryngology* (p. 36).
- BAGHDASSARIAN, Sahag b. 1937, Beirut, Lebanon. Lebanese. *Class of '63* (p. 94).
- BAHU, Raja b. 1936, Jerusalem, Palestine. Jordanian. *Class of '62* (p. 87).
- BALASSANIAN, Neron S. b. 1932, Recht, Iran. Iranian. *Class of '61* (p. 74-83).

(Contd. on page 143)

Votre amie fidèle
la Volkswagen

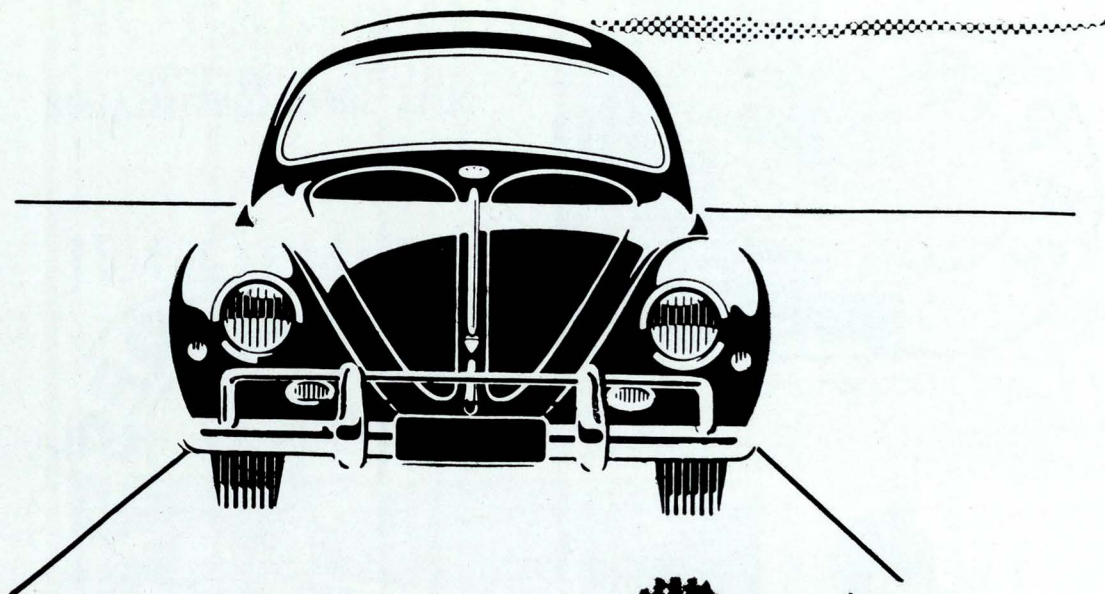

Distributeurs :

F.A. KETTANEH (Kettaneh Frères) S.A.

Rue du Port
Tél 21180

PUB BASSOUL

SNIP AI-9-58



Voyagez pour
EUROPE



AVEC LE
Confort
DE LA SUPER CONSTELLATION



AIR-INDIA  *International*

IMM. DE L'UNION NATIONALE • TEL.: 40900

AGENTS GENERAUX : HITTI FRERES - RUE DU PARLEMENT TEL.: 21765 et 37670



G A L E N I K A

NOVALGETOL

ANTIPYRETIC, ANALGETIC, ANTIRHEUMATIC & ANTISPASMODIC.

JUGOPHENICOL

BRAND OF LEVROTATORY CHLORAMPHENICOL.

JUGOCOMBIN

PENICILLIN - DIHYDROSTREPTOMYCIN.

Literatures on request

General representative for Lebanon :

REINA TRADING COMPANY

P. O. Box 2688 — Tél. : 35481, Beirut.

First with the finest

DU MONT

TELEVISION RECEIVERS

General Agents :

N. ZABBAT : Allembly St.

Tel. 28670

With the Compliments

of



Dumex

- BARSAMIAN, Misak b. 1937, Aleppo, Syria. U.A.R. *Class of '62* (p. 89).
- BARUDY, Maurice b. 1931, Souk-El-Gharb, Lebanon. Lebanese. *Class of '59* (p. 48, 57).
- BAWWAB, Samir M. b. 1936, Beirut, Lebanon. Lebanese. *Class of '61* (p. 74-83).
- BENDALI, Gloria b. Tripoli, El-Mina, Lebanon. Lebanese. M.D. '57, F.F.M. *Junior Assistant Resident in Pediatrics* (p. 35).
- BIKHAZI, Henry b. 1937, Akra, Gold Coast, Lebanese. *Class of '62* (p. 86).
- BILBISI, Abdul Aziz b. 1936, Irbid, Jordan. Jordanian. *Class of '62* (p. 91).
- BIRBARI, Adil E. b. 1933, Ziguinchor, French Occ. Africa. Lebanese. *Class of '59* (p. 48, 57).
- BISHARA, Faris M. b. 1934, Beka' Lebanon. Lebanese. *Class of '60* (p. 64).
- BISHARA, Munir b. 1937, Hama, Syria. U.A.R. *Class of '63* (p. 94).
- BITAR, Hanna G. b. 1937, Beirut, Lebanon. Lebanese. *Class of '60* (p. 65).
- BRANDSTATER, Bernard John b. 1929, Australian. M. B., B. S. University of Adelaide, F. A. C. A. Graduate School of Medicine, University of Pennsylvania, D.A., F.F.A.R.C.S. Royal College of Surgeons, England. *Associate Professor of Anesthesiology* (p. 31).
- BRIDI, George S. b. 1935, Beirut, Lebanon. Lebanese. *Class of '60* (p. 4, 65).
- CHAGLIASSIAN, Hrant T. b. 1905, Killis, Turkey. Lebanese. M.D. '31, A. U. B. *Professor of Dermatology et Syphilology* (p. 25).
- CHAKMAKJIAN, Zaven H. b. 1938, Aleppo, Syria. U.A.R. *Class of '63* (p. 94).
- CHORBAJIAN, Ropovt D. b. 1934, Beirut, Lebanon. Lebanese. M.D. '57, A.U.B. *Senior Assistant Resident in Internal Medicine* (p. 25).
- DABAJ, Emile N. b. 1934, Hama, Syria U. A. R. *Class of '60* (p. 64).
- DABBOUS, Ibrahim A. b. 1934, Beirut, Lebanon. Lebanese. *Class of '61* (p. 74-83).
- DAGHER, Fuad J. b. 1931, Sidon, Lebanon. Lebanese. M. D. '58, A. U. B. *Junior Assistant Resident in Surgery* (p. 30).
- DAGHER, Ibrahim b. 1925, Majdlouna, Lebanon. Lebanese. M. D. '51, A. U. B. *Assistant Professor of Surgery* (p. 30).

(Contd. on page 149)



Upjohn

Albanyen

T

- Terminates bacterial infection in a greater number of different clinical conditions than any other antibiotic.
- Bactericidal, not merely bacteriostatic, in the infections most *frequently* encountered.
- Eradicates resistant staphylococci, which constitute the greatest problem in antibiotic medicine today.
- Therapeutic doses cause fewer side effects than those of other antibiotics.
- Convenient, economical **b.i.d.** dosage.

Each tablet contains:
125 mg. novobiocin calcium and
125 mg. tetracycline hydrochloride.

Dosage:
Usually 2 tablets every 12 hours; in severe
infections 2 tablets three or four times
daily may be given.

Supplied:
Bottles of 16 tablets

UNION PHARMACEUTIQUE D'ORIENT
N. KHALYL, O. MAJDALANI & Cie

PHONE : 26153
BEIRUT

Frednisolone preparations *Merck*
for modern therapy
with adrenocortical hormones

DACORTIN *Merck*

DACORTIN *Merck*

Tablets of 5 mg.

Rheumatoid arthritis, bronchial asthma, Addison's disease,
nephroses, infectious diseases etc.

10 and 30 tablets

DACORTISAL

Tablets

containing Dacortin *Merck*, acetylsalicylic acid and vitamin C.
maintenance therapy of rheumatoid arthritis with low prednisolone
doses

20 tablets

DACORTIN *Merck*

Ointment 0.5%

Allergic skin diseases

Tubes of 5 gm.

SOLU-DACORTIN *Merck*

NEW

Lyophilised prednisolone 25 mg.

Intravenous injection in acute threatening conditions
(shock, intractable asthma, Addisonian crises)

1 ampoule



DARMSTADT · GERMANY

Agent:

In Lebanon: **Ibra. Hadad Fils & Co.,**
P.O. Box 20, BEIRUT

F. MAKHLOUF & Co.

144, DAMASCUS STREET - BEIRUT

P. O. BOX 983 - PHONE : 26221 - 42662

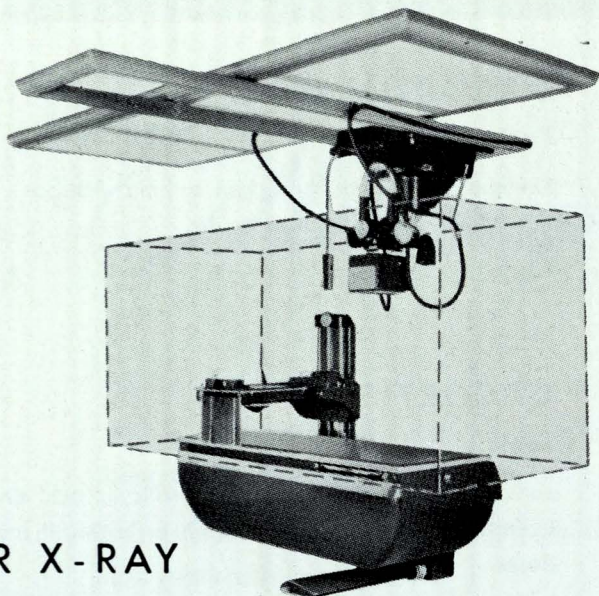

PICKER X-RAY
CONSTELLATION



PICKER INTERNATIONAL
CORPORATION

*

SANBORN

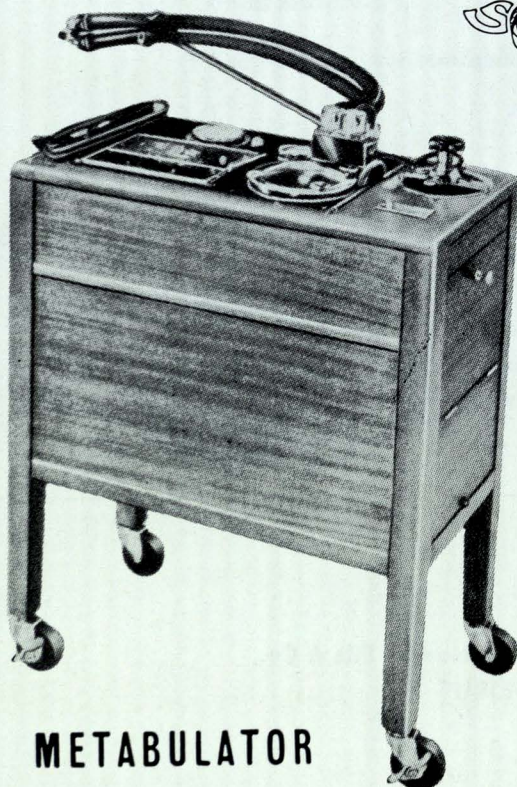

METABULATOR

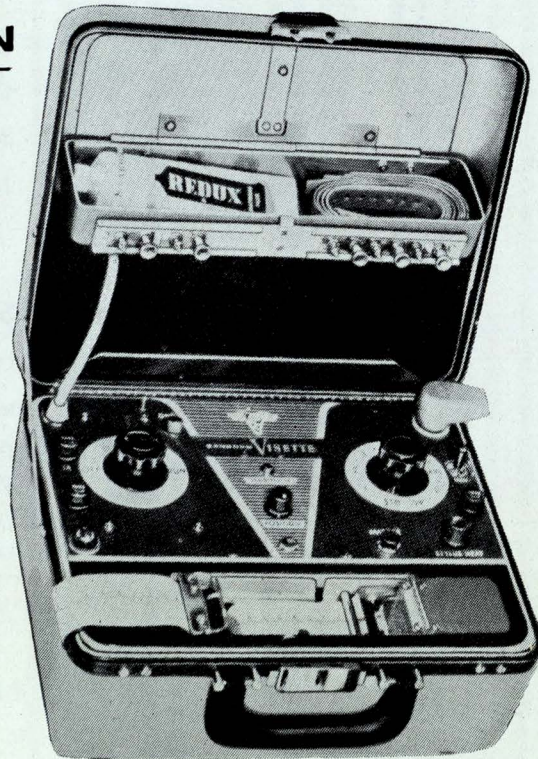

VISETTE 300

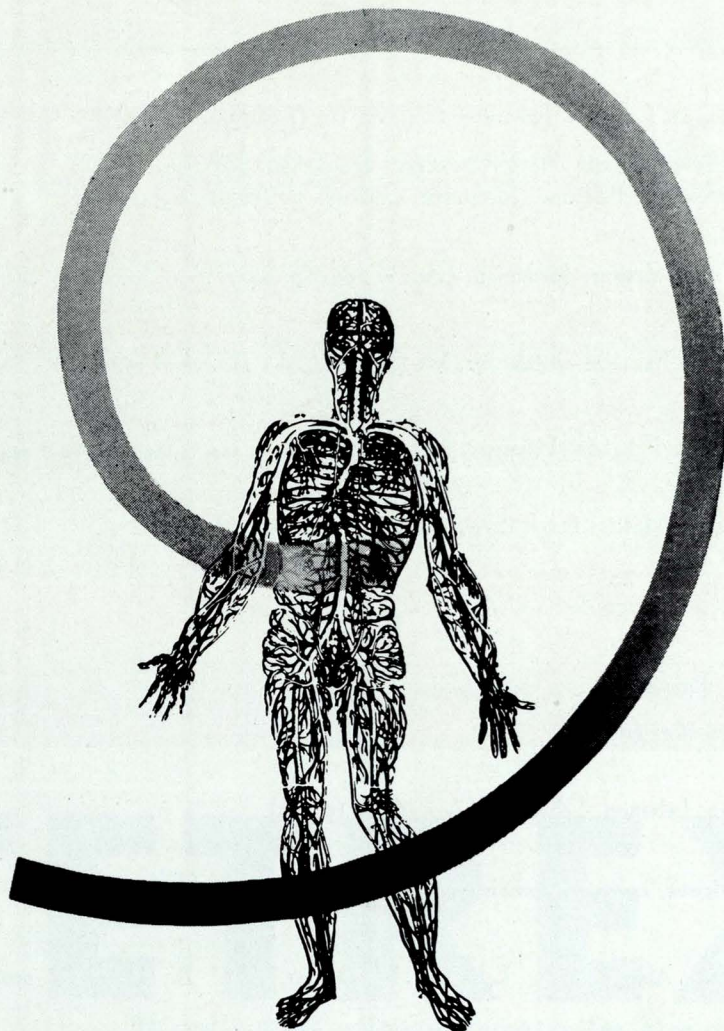

INTRODUCING :

CHLOROMYCETIN SUCCINATE

- SOLUTION REMAINS STABLE FOR 30 DAYS AT NORMAL ROOM TEMPERATURE.
- CAN BE USED IM - IV - SUBCUTANEOUS OR BY INHALATION.
- RAPID AND LONG LASTING THERAPEUTIC BLOOD LEVELS.
- WELL TOLERATED AT SITE OF INJECTION.

STERIVIAL OF 10 CC
CONTAINING 1 GM. OF CHLOROMYCETIN SUCCINATE

CHLOROMYCETIN SUCCINATE
SHOULD BECOME THE PREPARATION OF CHOICE IN THE FUTURE

SYDNEY ROSS M. D. et al
ANTIBIOTICS ANNUAL Page 803



PARKE - DAVIS & COMPANY, LIMITED

- DAGHER, Rifat b. 1934, Majdlouna, Lebanon. Lebanese. *Class of '62* (p. 87).
- DAJANI, Adnan S. b. 1936, Jerusalem, Palestine. Jordanian. *Class of '60* (p. 62, 64, 107).
- DAJANI, Isam b. 1936, Jerusalem, Palestine. Jordanian. *Class of '63*. (p. 94).
- DAJANI, Taher b. 1930, Jerusalem Palestine. Jordanian. M. D. '53, A. U. B. *Senior Assistant Resident in Surgery* (p. 30).
- DAOUD, Kamal T. b. 1915, Beirut, Lebanon. Lebanese. M.D. '37, A.U.B. *Instructor in Physiology and Tropical Health* (p. 21).
- DER KALOUSTIAN, Vasken b. 1937, Moussa Dagh, Syria, Lebanese. *Class of '63* (p. 94).
- DEYIRMENJIAN, Harutune b. 1936, Aleppo, Syria U.A.R. *Class of '62* (p. 90).
- DIAB, Alfred b. 1908, Rio de Janero, Brazil, U. S. Citizen. M. D. '32, A.U.B. F. A. C. S. '47, F. I. C. S., *Professor of Ophthalmology and Otolaryngology* (p. 36).
- DIB, Ibrahim b. 1937, Amyoun, Lebanon. Lebanese. *Class of '62* (p. 87).
- DJANIAN, Nubar Y. b. 1926, Beirut, Lebanon. Lebanese. *Class of '61* (p. 73-84).
- DRAGASTI, Gregoire A. b. 1906, Aleppo, Syria. Lebanese. M. D. '30, A. U. B., D. T. M. and H. England '35. *Associate Clinical Professor of Medicine* (p. 26).
- DROOBY, Ala'-ud-Din b. 1925, Homs, Syria U.A.R. M. D. University of Lausanne. *Instructor in Psychiatry* (p. 38).
- EKNOYAN, Garabed b. 1935, Aleppo, Syria U.A.R. *Class of '61* (p. 4, 74-83, 107).
- FARHAT, Yahya A. b. 1932, Amman, Jordan. Jordanian. M. D. '57, A. U. B. *Senior Assistant Resident in E.E.N.T.* (p. 36).
- FARIS, Amin A. b. 1934, Jerusalem, Palestine, Lebanese. M. D. '58, A. U. B. *Junior Assistant Resident in Medicine* (p. 27).
- FAWAZ, George A. b. 1913, Deir Mimas, Lebanon. Lebanese. M. S. '35, A. U. B., Ph. D. '36 University of Graz, M. D. '55 University of Heidelberg. *Professor of Pharmacology* (p. 21).
- FAWAZ, Youssef Rashid b. 1935, Sao Paolo, Brazil. Brazilian. *Class of '61* (p. 74-83).
- FIRZLI, Salim S. b. 1922, Damascus, Syria. Lebanese. M. D. '47, A.U.B. *Assistant Professor in Pediatrics* (p. 35).

(Contd. on page 155)

Now!

in broad-spectrum antibiotic therapy



TETREX

Bristol's more efficient tetracycline

CAPSULES

SYRUP

PEDIATRIC DROPS

INTRAMUSCULAR

100 and 250 mg.

For superior therapeutic results

A DOSAGE FORM—ORAL OR PARENTERAL—FOR EVERY CASE



With the Compliments of Hyka

HYKALM (Meprobamate)

BOTTLES OF 12 TABLETS 400 mg EACH

DIODO - HYKA (Diodo - hydroxyquinolein)

TUBES OF 15 TABLETS 0.65 gm. EACH

BOTTLES OF 60 TABLETS 0.65 gm. EACH.

HYKAVER (Brand of Piperazine)

ELIXIR IN BOTTLES OF 1 AND 4 OUNCES

BOTTLES OF 30 TABLETS 0.3 gm. EACH.

HYKA Pharmaceutical Laboratory
Bab-Edriss
Tel. 33611

SNIP

Pepsi-Cola



preferred
by people
of distinction



Pepsi-Cola

SOCIÉTÉ MODERNE LIBANAISE POUR LE COMMERCE S. A.

Rauwiloid A Better Antihypertensive

“We prefer to use alseroxylon (Rauwiloid)

since it is less likely to produce excessive fatigue and weakness than does reserpine.” Up to 80% of patients with mild labile hypertension and many with more severe forms are controlled with Rauwiloid alone.

1. Moyer, J.H.: J. Louisiana M. Soc.
108:231 (July) 1956.

A Better Tranquilizer, too

“... relief from anxiety resulted in generally increased intellectual and psychomotor efficiency with a few exceptions.”² Rauwiloid is outstanding for its *nonsoporific* sedative action in a long list of unrelated diseases not necessarily associated with hypertension but burdened by psychic overlay.

2. Wright W.T., Jr. et al.: J. Kansas M. Soc.
57:410 (July) 1956.

Dosage : Merely two 2 mg. tablets at bedtime.
After full effect one tablet suffices.

Best first step when more potent drugs are needed

Rauwiloid is recognized as basal medication in all grades and types of hypertension. In combination with more potent agents it proves synergistic or potentiating, making smaller dosage effective and freer from side actions.

RAUWILOID + VERILOID

In moderate to severe hypertension this single-tablet combination permits long-term therapy with dependably stable response. Each tablet contains 1 mg. Rauwiloid and 3 mg. Veriloid. Initial dose, 1 tablet t.i.d., p.c.

In Angina Pectoris

The Attacks Lessen and The Patient Loses His Fear

Pentoxylon

Each long-acting tablet provides the sustained coronary vasodilating effect of 10 mg. pentaerythritol tetranitrate (PETN) as well as the tranquilizing, anxiety-relieving and pulse-normalizing action of 0.5 mg. Rauwiloid (alseroxylon).

- Reduces incidence of attacks
- Reduces severity of attacks
- Reduces or abolishes need for fast-acting vasodilating drugs
- Reduces tachycardia
- Reduces blood pressure in hypertensives, not in normotensives
- Increases exercise tolerance
- Produces demonstrable ECG improvement
- Exceptionally well tolerated
- Minimal side actions
- **Dosage :** One to two tablets q.i.d. before meals and on retiring.

RIKER LOS ANGELES



SANDOZ PREPARATION

The result of

original chemical and pharmacological

research

supported by world-wide clinical trials

- FULEIHAN, Amin F. b. 1936, Beirut, Lebanon, Lebanese. *Class of '61* (p. 74-83).
- FULEIHAN, Farid b. 1930, Haifa, Palestine. Lebanese. M. D. '54, A. U. B. *Senior Assistant Resident in Internal Medicine* (p. 24).
- FULAYFIL, Rashid A. b. 1931, Moharraq, Bahrein, Bahreini. *Class of '59* (p. 48, 57).
- GARABEDIAN, Garabed A. b. 1914, Kharput, Turkey. Lebanese. M. S. '49, A. U. B., Ph. D. '55, University of Minnesota. *Assistant Professor of Bacteriology and Virology* (p. 23).
- GARABEDIAN, Mamigon b. 1935, Aleppo, Syria U. A. R. *Class of '62* (p. 90).
- GAZZAWI, Omar A. b. 1932, Mecca, Saudi Arabia. *Class of '61* (p. 74-83).
- GEBEYEHOU, Shimellis b. 1934, Addis Ababa, Ethiopia. Ethiopian. *Class of '61* (p. 74-83).
- GHANTUS, Musa K. b. 1903, Amyoun, Lebanon. Lebanese. M. D. '28, A. U. B. *Professor of Anatomy, Associate Dean of the Medical Faculty* (p. 20).
- GHARIZI, Shawki b. 1938, Lagos, Lebanese. *Class of '63* (p. 95).
- GHAZANFAR, Syed Alef Shah b. 1927, Lagar, Afghanistan. Afghani. *Class of '61* (p. 65).
- GIACCAI, Leonardo M. b. 1914, Pescia, Italy. Italian. M. D. '37, University of Florence. *Professor of Roentgenology* (p. 37).
- GIRAGOS, Henry G. b. 1935, Aleppo, Syria U. A. R. *Class of '63* (p. 65).
- GIRAGOS, John G. b. 1937, Aleppo, Syria U. A. R. *Class of '63* (p. 95).
- GOBEZIE, Gebrechristos b. 1932, Adwa, Ethiopia. Ethiopian. *Class of '60* (p. 65).
- GUEYIKIAN, Berj b. 1936, Beirut, Lebanon, Lebanese. *Class of '62* (p. 90).
- GULESSERIAN, Hrair b. 1936, Beirut, Lebanon. Lebanese. *Class of '61* (p. 4, 74-83).
- HABTEH, Demissie b. 1935, Modjo, Ethiopia. Ethiopian. *Class of '61* (p. 74-83).
- HADDAD, Amin b. 1939, Beirut, Lebanon. Lebanese. *Class of '61* (p. 95).
- HADDAD, Fuad S. b. 1924, Beirut, Lebanon. Lebanese. M. D. '48, A. U. B., F. R. C. S. Canada '54. *Assistant Clinical Professor of Surgery* (p. 29).

(Contd. on page 161)

**A CHANGE
IN THE
MOLECULAR
STRUCTURE
OF CHLOTRIDE***



**THE
MOST
EFFECTIVE
OF ALL
DIURETICS**

DiCHLOTRIDE

hydrochlorothiazide

**NOW PROVIDES
A POTENCY
MANY TIMES
GREATER**



MERCK SHARP & DOHME INTERNATIONAL
DIVISION OF MERCK & CO., INC., 100 Church Street, New York 7, N. Y., U.S.A.

AGENTS:

**ARABIAN DRUG COMPANY
SOUK EL KIZAZ - FARRA Bid.
TEL.: 41280 - 34579
BEIRUT**

F. MAKHLOUF & Co.

144, DAMASCUS STREET - BEIRUT

P. O. BOX 983 - PHONE : 26221 - 42662

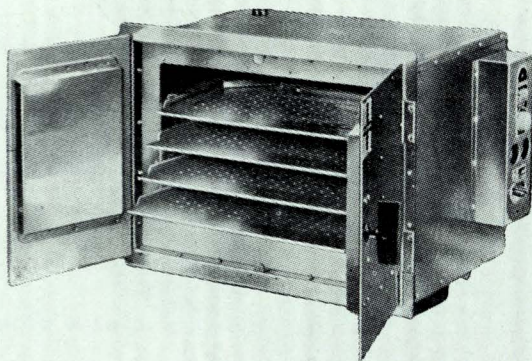

THENOT FILS & GENDRE

HOT AIR STERILIZERS,

ELECTRIC STERILIZERS

DRESSING CONTAINERS



Etablissement LEQUEUX

STERILIZERS FOR ALL

REQUIREMENTS OF

HOSPITALS, CLINICS

& LABORATORIES

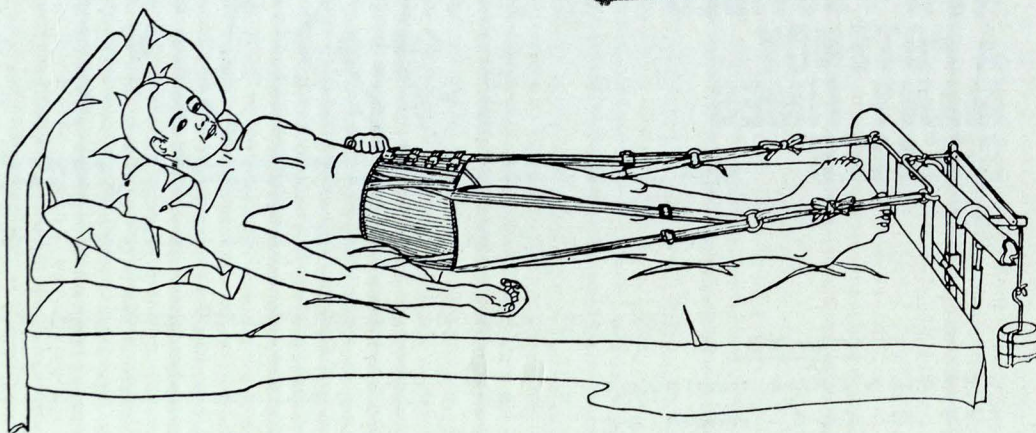
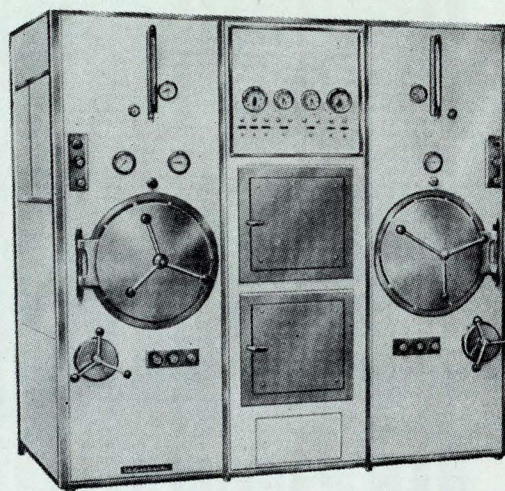

ZIMMER Mfg. COMPANY

FRACTURE EQUIPMENT

For the treatment of chronic Amoebiasis



Entamide

ENTAMIDE is now firmly established in the treatment of chronic amoebiasis, being superior to older remedies such as E.B.I., carbarsone, B.P., iodochlorohydroxyquinoline, or antibiotics.

ENTAMIDE given orally has a high cure rate and is **Non-Toxic, Specific in Action, Inexpensive, Low Relapse Rate**

ENTAMIDE TABLETS

Entamide is protected by patent applications throughout the world.

BOOTS PURE DRUG COMPANY LIMITED NOTTINGHAM ENGLAND

JOSEPH DICHY & CO. P.O. BOX 207, BEIRUT



ENTAMIDE 0.5 G. — Bottle of 40 tablets (Chronic colonic amoebiasis)

ENTAMIDE with CHLOROQUINE — Bottle of 80 tablets (Hepatic amoebiasis)

NEW Lady Sheaffer

'SKRIPTSERT' FOUNTAIN PEN



never goes near an ink bottle!

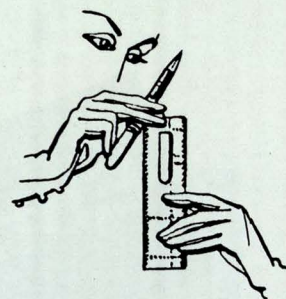

a fine fountain pen...a fashion accessory!

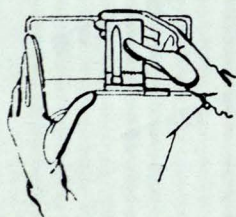

always at hand when you need it!

SKRIPTSERT
THE PERFECT CARTRIDGE-
LOADING INK

SHEAFFER'S

SOLD THROUGH BETTER STATIONERY AND GIFT SHOPS



**WE WON'T
"SETTLE"**



**FOR
ANYTHING
ELSE!**



NOT JUST AN ADULT DRINK ...

NOT JUST A DRINK FOR YOUNGSTERS!



IT'S THE ALL-FAMILY DRINK!

**SO PURE... SO GOOD...
SO WHOLESOME FOR EVERYONE!**



**THERE IS
ONLY ONE.....**



- HADDAD, Nadra E. b. 1933, Beirut, Lebanon. Lebanese. M. D. '58, A. U. B. *Junior Assistant Resident in Medicine* (p. 26).
- HADDAD, Shafik N. b. 1910, Haifa, Palestine. Lebanese. M. D. '34, A. U. B., D. T.M. Liverpool '38. M.R.C.P. Edinburgh '55. *Associate Clinical Professor of Internal Medicine* (p. 25).
- HADIDIAN, Henry A. b. 1935 Kassab, Syria Lebanese. *Class of '60* (p. 64).
- HAIJJAR, Jean Jaques A. b. 1934, Souk-El-Gharb, Lebanon. *Class of '60* (p. 64).
- HALASA, Adnan b. 1930, Kerak, Jordan. Jordanian. M. D. '55, A. U. B. *Senior Assistant Resident in E. E. N. T.* (p. 36).
- HAMZEH, Khalid b. 1938, Haifa, Palestine. Lebanese. *Class of '61* (p. 74-83).
- HANISSIAN, Aram S. b. 1929, Sanjak, Turkey. Lebanese. M. D. '58, A. U. B. *Junior Assistant Resident in Surgery* (p. 30).
- HAPTE-Michael, Aklog b. 1931, Harar, Ethiopia. Ethiopian. *Class of '59* (p. 49, 58).
- HARFOUCHE, Jamal K. b. 1914, Jezziz, Lebanon. Lebanese. M.D. '41, A.U.B. *Lecturer in Maternal and Child Health. On leave.*
- HAYEK, Jean K. b. 1922, Bishmizzin, Lebanon. Lebanese. M.D. '47, A.U.B. *Instructor in Psychiatry* (p. 38).
- HEMADEH, Kamal T. b. 1930, Beirut, Lebanon. Lebanese. M.D. '56, A.U.B. *Resident in Surgery* (p. 29).
- HOVHANESSIAN, Raffy b. 1938, Beirut, Lebanon. Lebanese. *Class of '62* (p. 90).
- HUSSEINI, Rudayna b. 1934, Jerusalem, Jordan. Jordanian. *Class of '62* (p. 88).
- ID, Adam M. b. 1935, Moharraq, Bahrein. Bahreini. *Class of '60* (p. 64).
- IDRISS, Hassan M. b. 1914, Beirut, Lebanon. Lebanese. M.D. '37, A.U.B. *Associate Clinical Professor of Pediatrics* (p. 34).
- ILIIYA, Fawzi A. b. 1933, Beirut, Lebanon. Lebanese. *Class of '59* (p. 49, 57).
- INJEJIK, Jirar b. 1936, Aleppo, Syria. U.A.R. *Class of '62* (p. 89).
- ISAAC, Bernard A. b. 1936, Freetown, Sierra Leone B.W.A. British. *Class of '61* (p. 72, 74-83).
- ISKANDAR, George B. b. 1935, Nazareth, Palestine. Palestinian. *Class of '60* (p. 65).
- ISSA, Philip B. b. 1927, Zahle, Lebanon. Lebanese. M.D. '53, F.F.M. *Instructor in Radiology* (p. 37).

(Cond. on page 165)

Scar

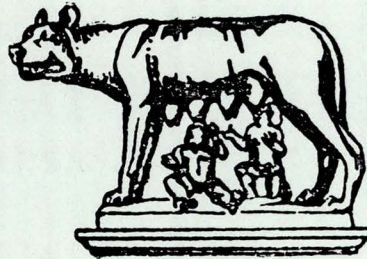

PLURICILLIN

Procain Penicillin & Streptomycin combination
1/4, 1/2 and 1 gram formula

STRECILLIN

Crystalline Penicillin (1.000.000 u) and Streptomycin
combination 1/4, 1/2 and 1 gram formula

NEW

DEVALILE OINTMENT

DEVALILE SPRAY

} best treatment for eczema
and allergic dermatites

Literature on request

Exclusive Agent :

SAYEGH DRUG STORES — BECHARA KHOURY Str. Gannagé Bldg. — Beirut.

Carl Zeiss

For any technical Information about
BAUSCH & LOMB
PRODUCTS

Call

THE NEAR EAST OPTICAL Co.

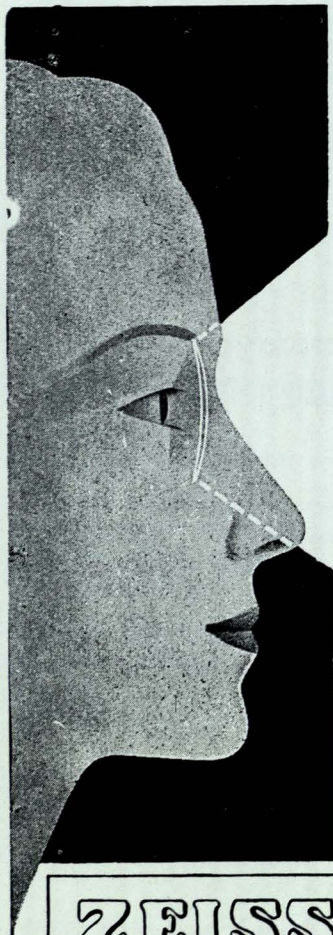

ZEISS

Qu'il s'agisse de verres sphériques
ou de verres pour astigmatisme, les
VERRES PUNKTAL ZEISS conservent
au regard toute sa mobilité. Les
VERRES PUNKTAL ZEISS donnent
un champ visuel très net,
jusque sur les bords. Les
VERRES PUNKTAL ZEISS sont
calculés dans les conditions op-
tima pour montage sur les lunettes
modernes à champ agrandi.



BECHARA KHOURY STREET
PUBLIC WORKS BUILDING
BEIRUT — PHONE ; 30837



FOR THE BENEFIT OF
OPHTHALMOLOGY AND THE SICK
ZEISS APPOINTED DISTRIBUTOR

OPTICA

BAB-EDRISS SQUARE
BEIRUT - LEBANON



MANTOMIDE

(CHLORBETAMIDE)

Amoebicidal activity in vitro and in vivo

- *Does not contain heavy metals*
- *Rapid action*
- *Absolute security*
- *Protects intestinal flora*
- *Powerful action in small dosage.*
- *Treatment of short duration*



- JABIR, Raif M. b. 1934, Ainksour, Lebanon. Lebanese. *Class of '59* (p. 4, 49, 58).
- JAHSHAN, Samir H. b. 1933, Jerusalem, Palestine. Palestinian. *Class of '59* (p. 51, 58).
- JAHAH, Khaldun b. 1936, Damascus, Syria. U.A.R. *Class of '63* (p. 95).
- JAMGOTCHIAN, Senekerim b. 1936, Beirut, Lebanon. Lebanese. *Class of '63* (p. 95).
- JANNUN, Said b. 1937, Beirut, Lebanon. Lebanese. *Class of '63* (p. 95).
- JARRAH, Azmi b. 1935, Acre, Palestine. Palestinian. *Class of '61* (p. 74-83).
- JIDEJIAN, Yervant D. b. 1906, Aleppo, Syria. Lebanese. M.D. '28, A.U.B., F.A.C.S., F.I.C.S. '52 *Clinical Professor of Surgery* (p. 28).
- JIHA, Iskandar S. b. 1936, Beirut, Lebanon. Lebanese. *Class of '59* (p. 50, 58).
- KABBANI, Mahmoud b. 1936, Beirut, Lebanon. Lebanese. *Class of '62* (p. 87).
- KABBANI, Salma M. b. 1933, Beirut, Lebanon. Lebanese. M.D. '57, A.U.B. *Senior Assistant Resident in Obs. et Gyn.* (p. 32).
- KABBANI, Sami b. 1937, Damascus, Syria. U.A.R. *Class of '62* (p. 87).
- KADI, Samir E. b. 1933, Haifa, Palestine. Lebanese. *Class of '60* (p. 65).
- KAID-BEY, Sami A. b. 1930, Ain-Anoub, Lebanon. Lebanese. M.B. '57, A.U.B. *Senior Assistant Resident in Int. Medicine* (p. 25).
- KANA'AN, Atallah Naim b. 1932, Talabaya, Lebanon. Lebanese. *Class of '61* (p. 4, 74-83).
- KANA'AN, Khattar Y. b. 1941, Abey, Lebanon. Lebanese. M.D. '40, A.U.B. *Assistant Hospital Anesthetist* (p. 31).
- KANA'AN, Munir A. b. 1903, Abey, Lebanon. Lebanese. M.D. '28, A.U.B. *Associate Clinical Professor of Pharmacology* (p. 21).
- KARAM, Jim b. 1938, Kumasi. British. *Class of '63* (p. 95).
- KATUL, Munir b. 1937, Shweir, Lebanon. Lebanese. *Class of '62* (p. 88).
- KERR, Stanley E. b. 1894, Hopewell, New Jersey. American. Ph. D. '25, University of Pennsylvania. *Professor of Biochemistry* (p. 21).

(Contd. on page 169)

ATTACK *infection and inflammation...*

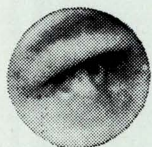

EYE

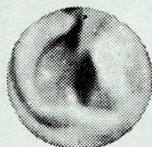

EAR

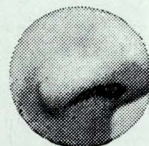

NOSE

"FLAVACO"

is active against gram-positive and gram-negative organisms.

"FLAVACO" NASAL SPRAY

No. 928 "Frosst"

An aqueous isotonic solution of:

Gramicidin.....	0.005%
Neomycin sulphate.....	0.1%
Ephedrine hydrochloride.....	0.3%
Aminacrine hydrochloride.....	0.1%

SUPPLIED: 15 cc. plastic spray bottles.

"FLAVACO" with Hydrocortisone OPHTHALMIC DROPS

No. 930 "Frosst"

A sterile aqueous solution of:

Gramicidin.....	0.005%
Neomycin sulphate.....	0.1%
Aminacrine hydrochloride....	0.1%
Hydrocortisone.....	0.02%

SUPPLIED: 3 cc. plastic tubes with dropper tip.

"FLAVACO" with Hydrocortisone OINTMENT (OPHTHALMIC)

No. 933 "Frosst"

Gramicidin.....	0.005%
Neomycin sulphate.....	0.1%
Aminacrine hydrochloride....	0.1%
Hydrocortisone.....	1.5%

SUPPLIED: 1.5 G. tubes.

"FLAVACO" with Hydrocortisone OTIC

No. 931 "Frosst"

An anhydrous solution of:

Gramicidin.....	0.025%
Neomycin sulphate.....	0.25%
Aminacrine hydrochloride....	0.1%
Hydrocortisone.....	0.02%
Benzocaine.....	2.0%

SUPPLIED: 15 cc. bottles with dropper.



Charles E. Frosst & Co.
MONTREAL CANADA

EUROPE

by Jet-Powered Super *VISCOUNTS* to

ISTANBUL

Every Tuesday, Thursday and Saturday.



ATHENS

Every Tuesday, Thursday, Friday, Saturday and Sunday.



ROME

Every Tuesday, Thursday and Saturday.



VIENNA

Every Tuesday, Thursday and Saturday.

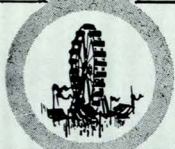

GENEVA

Every Wednesday, Friday and Sunday.



FRANKFURT

Every Tuesday, Thursday and Saturday.



LONDON

Daily (Except Mondays)



FOR INFORMATION AND BOOKINGS :

Consult your Travel Agent or Middle East Airlines, Beirut,
Bab-Edriss, Abboud Bldg., Tel. 21212/3/4/5, Ras Beirut,
Uncle Sam Bldg., Tel. 23939, Maktabi Bldg., Omar Ben-
Abdel-Aziz Street, Tel. 21420

TOWN TERMINAL

Ahmad Chawki Street, Opposite Palm Beach Hotel,
Tel. 41020



MIDDLE EAST AIRLINES

B. O. A. C. Associate

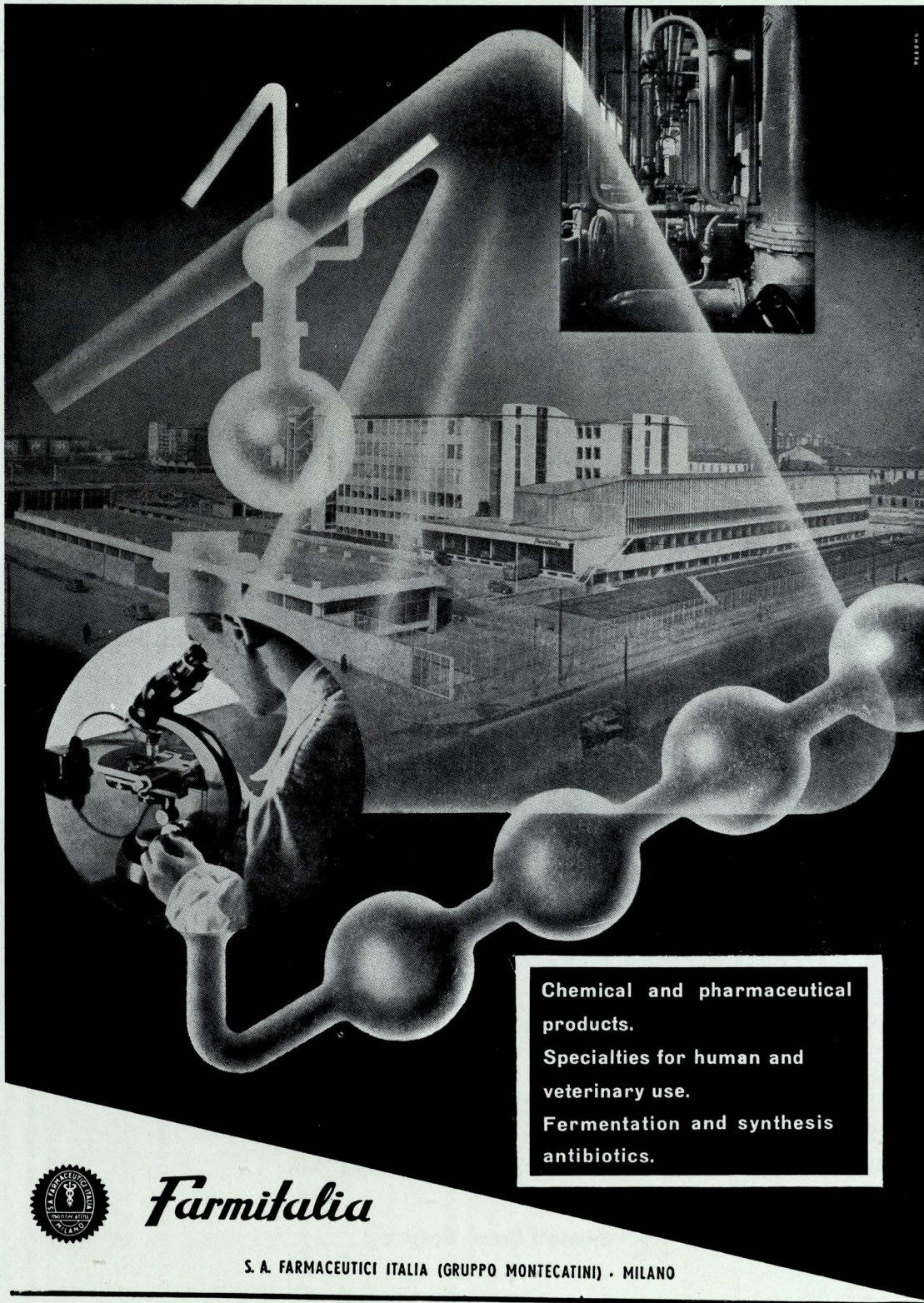

Chemical and pharmaceutical products.

Specialties for human and veterinary use.

Fermentation and synthesis antibiotics.



Farmitalia

S. A. FARMACEUTICI ITALIA (GRUPPO MONTECATINI) - MILANO

REPRÉSENTANT AU LIBAN

SPÉCIALITÉS PHARMACEUTIQUES « SPEPHAL »

Rue Patriarche Hoyek — B. P. 471 — Tél. : 21275

BEYROUTH

- KHATCHADURIAN, Avedis K. b. 1927, Beirut, Lebanon. Lebanese. M.D. '53, A.U.B. *Assistant Professor of biochemistry* (p. 21).
- KHALAF, Jawdat b. 1931, Jerusalem, Jordanian. M.D. '55, A.U.B. *Junior Assistant Resident in Internal Medicine* (p. 26).
- KHALIFAH, Riad R. b. 1934, Ain-Anoub, Lebanon. Lebanese. *Class of '59* (p. 50, 58).
- KHAYAT, Georges B. b. 1894, Aleppo, Syria. Lebanese. M. D. '22, A. U. B. *Clinical Professor of Internal Medicine* (p. 24).
- KHAZIN, Aida b. 1938, Nablus, Palestine. Lebanese. *Class of '62* (p. 88).
- KHOURY, Da'ad b. 1934, Safita, Syric. U. A. R. M. D. '58 F. F. M. *Junior Assistant Resident in Pediatrics* (p. 35).
- KHURI, Raja K. b. 1937, Jerusalem, Palestine. Lebanese. *Class of '61* (p. 4, 72, 74-83).
- KHURI, Raja N. b. 1935, Beirut, Lebanon. Lebanese. *Class of '59* (p. 4, 46, 50, 57, 107).
- KHURI, Nadim b. 1936, Jerusalem, Palestine. Jordanian. *Class of '61* (p. 74-83).
- KIDANE-MARIAM, Tesfaye b. 1933, Addis Ababa, Ethiopia. Ethiopian. *Class of '60* (p. 65).
- KIDANE-MARIAM, Widad b. 1935, Jerusalem, Palestine. Ethiopian. *Class of '59* (p. 50, 58).
- KILEJIAN, Vahe b. 1936, Beirut, Lebanon. Lebanese. *Class of '63* (p. 95).
- KUBLAWI, Isam b. 1937, Acre, Palestine. Palestinian. *Class of '62* (p. 88).
- LUBBAT, Ilias K. b. 1931, Jerusalem, Palestine. Palestinian. *Class of '59* (p. 49, 59).
- MADONIAN, Ara S. b. 1934, Jerusalem, Palestine. Lebanese. *Class of '59* (p. 51, 59).
- MAJDHUB, Hisham S. b. 1934, Beiteddine, Lebanon. Lebanese. *Class of '60* (p. 66, 107).
- MAKHOULAH, Zahi N. b. 1935, Nazareth, Palestine. Palestinian. *Class of '60* (p. 66).
- MAKKI, Mohamad b. 1936, ErKay, Lebanon. Lebanese. *Class of '63* (p. 95).
- MALHAS, Abdur-Rahim b. 1937. Amman, Jordan. Jordanian. *Class of '63*.
- MALOUF, Nadya Najla b. 1937, Jerusalem, Palestine. Lebanese. *Class of '63* (p. 95).

(Contd. on page 173)

With the Compliments

of

TAPLINE

- MANGO, Aida A. b. 1934, Amman, Jordan. Jordanian. *Class of '60* (p. 67).
- MANN, Philip E. b. 1934, Wisconsin, American. *Class of '61* (74 - 83).
- MANOUGIAN, Antranig S. b. 1910, Harpout, Turkey. British Citizen. M. D. '35, A. U. B. Diploma in Psychiatry, '39, University of Edinburgh *Associate Clinical Professor of Psychiatry* (p. 38).
- MANOUKIAN, Hratch b. 1935, Beirut, Lebanon. Lebanese. *Class of '61* (p. 74-83).
- MANSOUR, Edward b. 1935, Bethlehem, Palestine. Jordanian. *Class of 62* (p. 84, 88).
- MASRI, Anwar b. 1938, Mreijat, Lebanon. Lebanese. *Class of '63* (p. 93).
- MATTA, Camil b. 1926, Bhamdoun, Lebanon. Lebanese. M. D. '50, A. U. B. *Assistant Professor of Ophthalmology* (p. 36).
- MCDONALD, Joseph J. b. 1913, Seattle, Washington. American. M. S. '39, and M. D. '40 North Western University. D. Med. Sc. '47 Columbia University *Professor of Surgery and Dean of the Faculty of Medical Sciences*.
- MEKHJIAN, Hagop b. 1937, Aleppo, Syria. U. A. R. *Class of '62* (p. 89).
- MEYMERIAM, Mrs. Euphronia, Lebanese. B. A., A. U. B. *Teaching Instructor in Tropical Health* (p. 23).
- MIKAELIAN, Diran O. b. 1928, Aleppo, Syria. U. A. R., M. D. '54, A. U. B. *Assistant Instructor in E. E. N. T.* (p. 31).
- MITCHELL Howard b. 1923, Evansville, Indiana. American. M. D. 1949 Indiana University (p. 40).
- MOACDIE, Jean N. b. 1923, Zahle, Lebanese. M. D. '47, A. U. B. *Clinical Instructor in Internal Medicine* (p. 27).
- MUALLEM, Musa K. b. 1928, Bleibel, Lebanese. M. D. '57, A. U. B. *Senior Assistant Resident in Anesthesia* (p. 31).
- MUFARRIJ, Afif H. b. 1908, Bishmizzin, Lebanon. Lebanese. M. D. '31, A. U. B. *Assistant Clinical Professor of Anatomy*(p. 20).
- MUFARRIJ, Ibrahim H. b. 1923, Bishmizzin, Lebanon. Lebanese. M. D. '47, A. U. B. *Assistant Professor of Obs. and Gyn.* (p. 33).
- MUKHAYBIR, Nabil Wadad F. b. 1929, Beit Mery, Lebanon. Lebanese. M. D. '57, A. U. B. *Senior Assistant Resident in Internal Medicine* (p. 25).
- MURUWWAH, Adnan b. 1936, Jeba, Lebanon. Lebanese. *Class of '61* (p. 74 - 83)
- MUSSALLAM, Salim b. 1936, Haifa, Palestine. Lebanese. *Class of '62* (p. 88).

(Contd. on page 173)

Des millions de malades:

**5 années de
traitement
oral du
diabète
sont la
preuve de la
sécurité
que
présente
l'emploi du**

Nadisan[®]



**Le nombre de malades traités au
Nadisan augmente d'année
en année**

**Effet de longue durée
confiance absolue
excellente tolérance**

100 ans boehringer

**Nadisan, le premier antidiabétique
actif par voie orale, une découverte
ayant ouvert de nouvelles voies
thérapeutiques, de la Maison
Boehringer Mannheim**

- MYERS, Rena B. b. 1900, Lynchburg, South Carolina, American. R. N. Toumey Hospital. *Lecturer in Anesthesiology* (p. 31).
- NACHMAN, Henry S. b. 1908, Damascus, Syria. U. A. R., M. D. '33, A.U.B. *Associate Clinical Professor of Pediatrics* (p. 35).
- NAFFOUJ, Jawdat b. 1936, Habnumrah, Syria. U. A. R. *Class of '63* (p. 95).
- NAHRA, Khalil b. 1934, Kfarshima, Lebanon. Lebanese. *Class of '61* (p. 74-83).
- NA'AMAN, Najla b. Sidon, Lebanon M. D. '55. *Junior Assistant Resident in Obs. and Gyn.* (p. 33).
- NASR, Amin T. b. 1936, Jerusalem, Palestine. Palestinian. *Class of '61* (p. 74-83, 107).
- NASSAR, Nadia b. 1935, Haifa, Palestine. Lebanese. *Class of '62* (p. 87).
- NASSAR, Munir E. b. 1934, Beirut, Lebanon. Lebanese. *Class of '59* (p. 51, 59).
- NASSAR, Sami I. b. 1932, Ainksour, Lebanon. Lebanese. *Class of '59* (p. 51, 59).
- NASSIF, Raif E. b. 1926, Beirut, Lebanon. Lebanese. M. D. '50, A. U. B. *Assistant Professor of Laboratory Studies* (p. 39).
- NSOULI, Afif Z. b. 1920, Beirut, Lebanon. Lebanese. M. D. '46, A. U. B. *Assistant Clinical Professor of Surgery* (p. 28).
- NUCHO, Charles N. b. 1916, Beirut, Lebanon. Lebanese. M.D. '44, A.U.B. *Instructor in Internal Medicine (Part Time)* (p. 27).
- OBEID, Sami J. b. 1924, Beirut, Lebanon. Lebanese. M. D. '49, A. U. B. *Assistant Professor of Surgery* (p. 30).
- PAINE, Harlan Jr. b. 1915, American. *Hospital Administrator* (p. 39).
- PARTAMIAN, Jean O. b. 1932, Beirut, Lebanon, Lebanese. *Class of '60* (p. 67).
- PASHA, Najdat b. 1930, Aleppo, Syria. U. A. R., M. D. '55, A. U. B. *Senior Resident in Surgery* (p. 28).
- PUZANTIAN, Vahé R. b. 1929, Beirut, Lebanon. Lebanese. L.H.M.N.D. *Resident Psychiatrist* (p. 38).
- PLIMPTON, Calvin b. 1918, Boston, Mass., American. M. D., M.S. Harvard Medical School., D. Med. Sc. Columbia University, *Professor of Internal Medicine* (p. 24).
- RADWAN, Anwar I. b. 1931, Beirut, Lebanon. Lebanese. *Class of '59* (p. 52, 60).
- RASHED, Rashed A. b. 1934, Manama, Bahrein. Bahreini. *Class of '60* (p. 67).

(Contd. on page 175)



ZEISS Every lens has Z mark on it

PUNKTAL Lateral vision is same as Central

SPECTACLES Latest styles with best fitting

CONTACT LENS Corneal and Scheral

MAJZOUB BROS

ZEISS

FACTORY ALLOWS A 10 % TO THE MEDICAL PROFESSION

PLASTIC ARTIFICIAL EYES.

POLAROID SUNGLASSES.

B & L MEDICAL INSTRUMENTS.

MICROSCOPES.

- RAYYIS, Suad S. b. 1936, Beirut, Lebanon. Lebanese. *Class of '63* (p. 92, 96).
- RAZZUK, Ma'rouf A. b. 1933, Hama, Syria. U.A.R. *Class of '60* (p. 66).
- RIFKA, Gabriel E. b. 1921, Kafroun, Syria. U.A.R., M.D. '50, A.U.B., D.T.M. & H., London. *Assistant Professor of Public Health Practice* (p. 40).
- RIMLAWI, Basim b. 1938, Jaffa, Palestine. Palestinian. *Class of '63* (p. 96).
- RIWADI, Naim b. 1935, Tripoli, Lebanon. Lebanese. *Class of '63* (p. 96).
- RODENKO, Tatyana G. b. 1935, Jaffa, Palestine. Palestinian. *Class of '59* (p. 52, 60).
- RUBEIZ, George A. b. 1929, Beirut, Lebanon. Lebanese. M.D. '53, A.U.B. *Instructor in Internal Medicine* (p. 27).
- RUBEIZ, Jean b. 1935, Beirut, Lebanon. Lebanese. *Class of '62* (p. 87).
- RUBAYZ, Michel T. b. 1932, Beirut, Lebanon. Lebanese. *Class of '59* (p. 52, 60).
- SAADEH, George b. 1936, Beirut, Lebanon. Lebanese. *Class of '62* (p. 88).
- SAAAB, Nikula G. b. 1934, Beirut, Lebanon. Lebanese. *Class of '59* (p. 52, 59).
- SAAAD, Atif b. 1931, Gharifeh, Lebanon. Lebanese. *Class of '59* (p. 53, 59).
- SABA, Maurice b. 1936, Nazareth, Palestine. Jordanian. *Class of '63* (p. 96).
- SABBAGH, Richard b. 1931, Palestine. Palestinian. *Class of '60* (p. 66).
- SABIR, Antoine b. 1936, Kfarshima, Lebanon. Lebanese. *Class of '62* (p. 87).
- SABRA, Fuad A. b. 1918, Beirut, Lebanon. M. D. '42, A. U. B. *Associate Professor of Neurology* (p. 26).
- SADIK, Alexander K. b. 1935, Bshirreh, Lebanon. Lebanese. *Class of '59* (p. 53, 60).
- SAGHIR, Marcel b. 1937, Amyoun, Lebanon. Lebanese. *Class of '63* (p. 96).
- SAHAKIAN, JOHN A. b. 1923, Beirut, Lebanon. Lebanese. M. D. '48, F. F. M. *Clinical Instructor in Obs. and Gyn.* (p. 33).
- SAHYOUN, Philip b. 1899 Abey, Lebanon. Lebanese. M. D. '22, A U. B. *Professor of Pathology* (p. 22).

(Contd. on page 177)

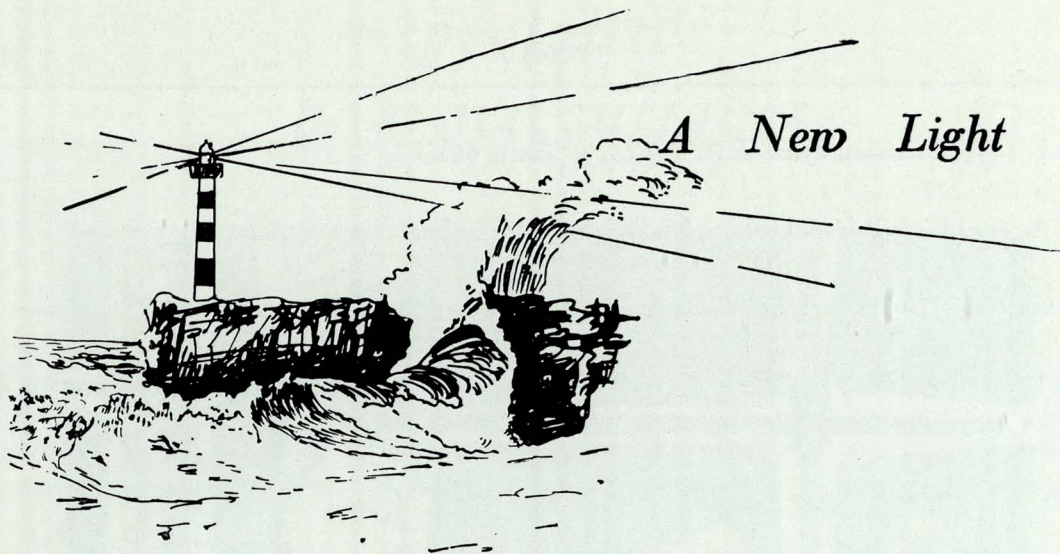

NEOPOLYCYN HC*

*Anti-inflammatory
Anti-infective therapy*

Neopolycin-HC provides Neomycin, Bacitracin, Polymixin B and Hydrocortisone, a most effective therapy against skin and eye disorders.

This combination is provided in the unique Fuzene base, which releases higher antibiotics and Hormones concentrations than is possible with grease-base ointment.

OPHTHALMIC OINTMENT

each gram contains:
 10,000 units Polymixin B
 500 units Bacitracin
 3 mg Neomycin
 10 mg Hydrocortisone
 1/8 oz tubes

TOPICAL OINTMENT

each gram contains:
 8,000 units Polymixin B
 400 units Bacitracin
 3 mg Neomycin
 10 mg Hydrocortisone
 1/6 oz tubes

* Trademark



PITMAN—MOORE COMPANY

division of Allied Laboratories, inc.,
 Indianapolis 6, Indiana.

exclusif agents:

LEVANT ALIÉ HOUSES, Dabbas square, Tel. 31756, P. O. Box 1780, Beirut

- SAKATI, Isam A. b. 1935, Damascus, Syria. U. A. R. *Class of '60* (p. 66).
- SALAM, Maria Z. b. 1924 Stryj, Poland. Lebanese. M. D. '50, A. U. B. *Instructor in Pediatrics* (p. 35).
- SALAMUN, Samir G. b. 1933, Mashghara, Lebanon. Lebanese. *Classe of '59* (p. 53, 60).
- SALSBY, George W. b. 1912, Souk-El-Gharb, Lebanon. Lebanese. M. D. '37, A. U. B. *Associate Professor of Roentgenology* (p. 37).
- SALEH, Suheil S. b. 1937, Jaffa, Palestine. Jordanian. *Class of '61* (p. 4, 72, 74-83).
- SALEM, Antun A. b. 1936, Btarran, Lebanon. Lebanese. *Class of '59* (p. 53, 60).
- SALMAN, Salah D. b. 1936, Beirut, Lebanon. Lebanese. *Classe of '61* (74-83).
- SALTY, Ibrahim b. 1941, Jerusalem, Jordan. Jordanian. *Class of '63* (p. 96).
- SALWAN, Fayez A. b. 1933, Aitaneet, Lebanon. *Class of '59* (p. 54, 60).
- SAMBAR, Shafik S. b. 1935, Haifa, Palestine. Lebanese. *Class of '60* (p. 67).
- SARRAFIAN, Edgar K. b. 1934, Beirut, Lebanon. Lebanese. *Class of '60* (p. 4, 67).
- SAWAYA, Elie b. 1935, Bteghrine, Lebanon. Lebanese. *Class of '63* (p. 96).
- SAYEGH, Roger b. 1937, Tripoli. Lebanon. Lebanese. *Class of '63* (p. 96).
- SCHINAZI, Lewis A. b. 1923, Chicago, Illinois. American. M. A., Ph. D. University of California, Los Angeles. *Assistant Professor of Parasitology and Tropical Health* (p. 23).
- SCHNEIDER, John b. 1931, Wisconsin, American. Ph. D. University of Wisconsin. *Assistant Professor of Biochemistry* (p. 21).
- SCHWABE, Calvin b. 1927, New Jersey. American. M.S., University of Hawaii. D.V.M. Alabama Polytechnic Institute. M.P.H., Sc. D. Harvard University. *Associate Professor of Parasitology* (p. 23).
- SHAHID, Munib J. b. 1909, Acre, Palestine. Iranian. M. D. '35, A.U.B. *Associate Clinical Professor of Internal Medicine* (p. 25).
- SHAHIN, Sami b. 1935, Beirut, Lebanon. Lebanese. *Class of '63* (p. 96).

(Contd. on page 179)

*spécialités
pharmaceutiques*

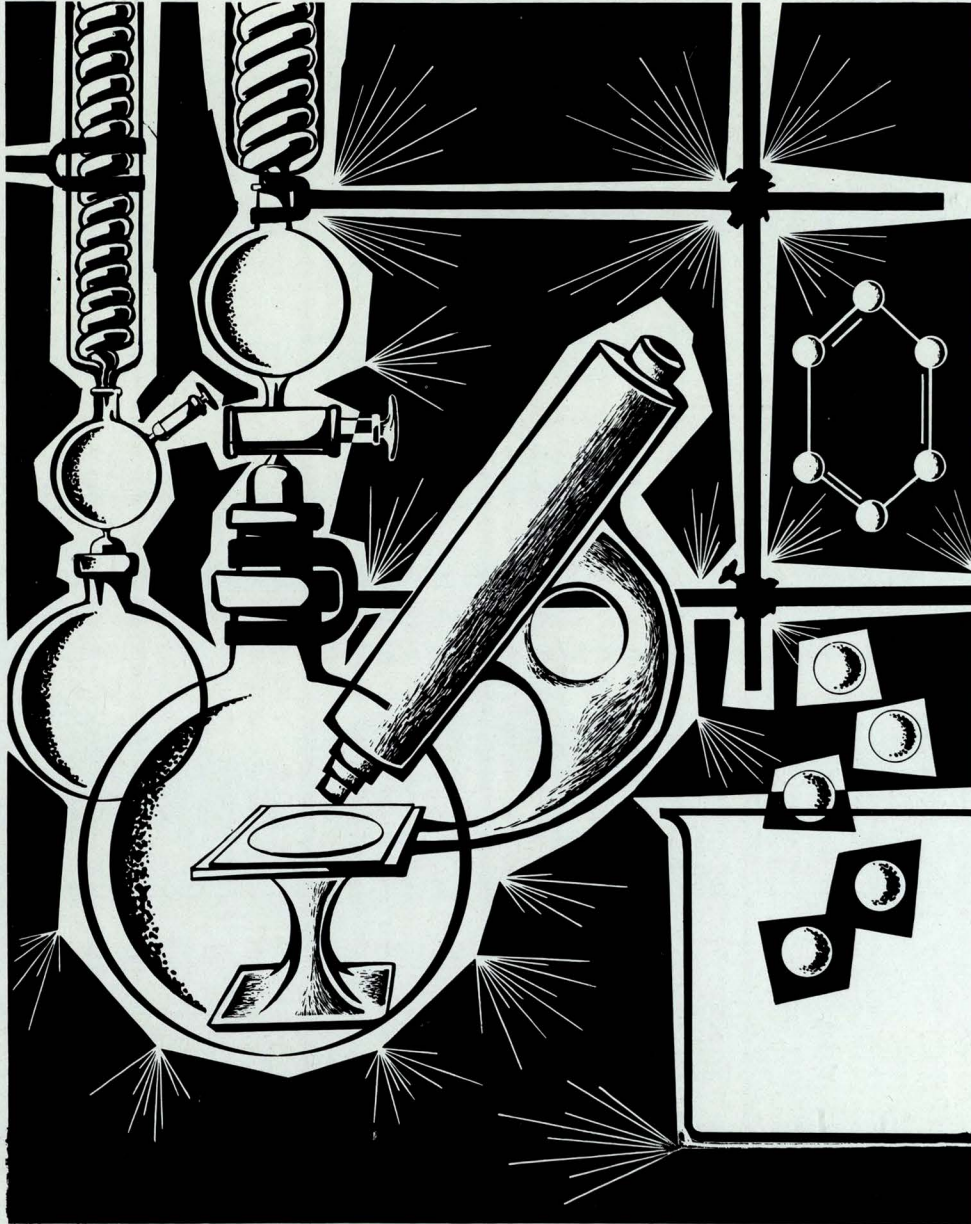

LATÉMA

31, RUE DE LISBONNE - PARIS-8^e

Dépositaire et Agent Exclusif pour le Liban :

G. & K. ANGHELOPOULO, Rue Patriarche Hoyek - Boîte postale 471 - BEYROUTH

- SHAKHASHIRI, Zaken A. b. 1912, Enfeh, Lebanon. Lebanese. M. S. '34, M. D. '38, A. U. B., M. P. H. '49 Johns Hopkins University. *Associate Professor of Preventive Medicine and Public Health* (on leave).
- SHAMMA, Mohamad Zaki b. 1934, Aleppo, Syria. U.A.R. *Class of '60* (p. 66).
- SHAMMA^{'A}, Munir b. 1927, Beirut, Lebanon. Lebanese. M. D. '51, A. U. B. *Clinical Instructor in Internal Medicine* (p. 27).
- SHANKLIN, William M. b. 1896, Fork Maryland, American. Ph. D. '29 Yale University, D. Sc. Bridgewater College. *Professor of Histology and Neuroanatomy* (p. 20).
- SHAWAR, Abdul-Muiz Y. b. 1935, Hebron, Palestine. Jordanian. *Class of '60* (60).
- SHEHADEH, Isam b. 1937, Keferyasif, Palestine. Lebanese. *Class of '62* (p. 88).
- SHEHADEH, Najib H. b. 1931, Beirut, Lebanon. Lebanese. M. D. '56, A. U. B. *Resident in Internal Medicine* (p. 24).
- SHEHADEH, Samir I. b. 1931, Zahlé, Lebanon. Lebanese. M. D. '56, A. U. B. *Resident in Surgery* (p. 29).
- SHIDYAK, Kaysar C. b. 1934, Aleppo, Syria. Lebanese. *Class of '59* (p. 54, 61).
- SHUAYB, Wihbi A. b. 1935, Sidon, Lebanon. Lebanese. *Class of '60* (p. 66).
- SHUMAN, Hind M. b. 1932, Baalbeck, Lebanon, Lebanese. M.D. '58, A.U.B. *Junior Assistant Resident in Internal Medicine* (p.26).
- SHWAYRI, Edmond I. b. 1922, Hadath, Lebanon. Lebanese. M.D. '46, A.U.B. *Assistant Professor of Internal Medicine* (p. 26).
- SILAH, Jack G. b. 1932, Aleppo, Syria. U. A. R. *Class of '60* (p. 66).
- SIMAN, Joseph A. b. 1933, Brummana, Lebanon, Lebanese. M. D. '58, A. U. B. *Junior Assistant Resident in Surgery* (p. 30).
- SIMAN, Suhayl b. 1937, Hama, Syria. U. A. R. *Class of '63* (p. 96).
- SINNU, Anwar A. b. 1935, Beirut, Lebanon. Lebanese. *Class of '62* (p. 87).
- SIRAGANIAN, Reuben b. 1940, Aleppo, Syria. U. A. R. *Class of '63* (p. 92, 96).
- SOSSOYAN, Meguerditch b. 1937. Cairo, Egypt. U. A. R. *Class of '63* (p. 96).
- SUIDAN, FAYEZ G. b. 1931, Haifa, Palestine. Lebanese. M. D. '55, A. U. B. *Senior Resident in Surgery* (p. 28).

(Contd. on page 181)

Venez Admirez...
... les splendides
modèles **PHILCO**

Le meilleur nom en TELEVISION

VOUS SEREZ EMERVEILLÉS DE:

**la richesse de la gamme
la beauté de chaque modèle
la netteté de réception**

PRIX TRÈS BIEN ETUDIÉS

garantie assurée par
des techniciens spécialisés

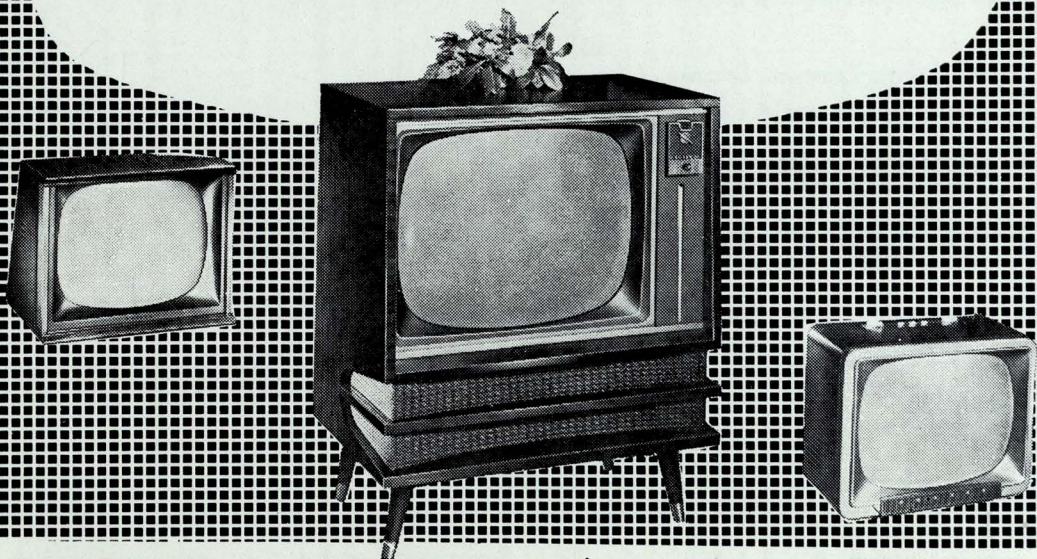

PENSEZ A L'AVENIR... et vous choisirez PHILCO

MALIKIAN FRERES RUE HOYEK

COME AND ADMIRE

THE SPLENDID **PHILCO** MODELS

- SUKI, Wadi N. b. 1934, Khartum, Sudan. Lebanese. *Class of '59* (p. 54, 61).
- SURUJI, Samir b. 1936, Haifa, Palestine. Palestinian. *Class of '63* (p. 97).
- SYVERSON, Lavand American. O.P.D. *Administrator* (p. 40).
- TABBARAH, Hassan J. b. 1933, Beirut, Lebanon. Lebanese. M. D. '57, A. U. B. *Senior Assistant Resident in Surgery* (p. 30).
- TABBARAH, Riad A. b. 1914, Beirut, Lebanon. Lebanese. M. D. '39, A.U.B. *Associate Professor of Internal Medicine* (p. 25).
- TAHA, Mohamad Riyad A. b. 1933, Zabadani, Syria. U. A. R. *Class of '60* (p. 66).
- TEDLA, Abraha b. 1932, Asmara, Eritrea. Ethiopian. *Class of '59* (p. 54, 61).
- TEFERRA, Admassu b. 1936, Harar, Ethiopia. Ethiopian. *Class of '61* (p. 73-84).
- TILKIAN, Sarko M. b. 1936, Beirut, Lebanon. Lebanes. *Class of '61* (p. 73-84).
- TINN, Najm b. 1932 Saghbeen, Lebanon. Lebanese. *Class of '61* (p. 73-84).
- TUMA, Amin b. 1935, Batrun, Lebanon. Lebanese. *Class of '61* (p. 73-83).
- TUQAN, Nimr A. b. 1922, Nablus, Palestine. Jordanian. M. D. '44, A. U. B. *Assistant Professor of Pathology* (p. 22).
- TUSHAN, Fayez b. 1935, Beirut, Lebanon. U. A. R. *Class of '61* (p. 73-84).
- TUTUNJI, Akil b. 1927 Amman, Jordan. Jordanian. M. D. '54, A. U. B. *Resident in Obs. and Gyn.* (p. 32).
- UBAYD, Yasir b. 1935, Hebron, Palestine. Jordanian *Class of '62* (p. 87).
- UWAYDAH, M. Marwan b. 1936, Tripoli, Lebanon. Lebanese. *Class of '61* (p. 73-84).
- VINCENTI, Alberto b. 1935 Haifa, Palestine. Italian. *Class of '62* (p. 87).
- WAHBAH, Nabilah b. 1938, Haifa, Palestine. Lebanese. *Class of '60* (p. 97).
- WANNA, Hanna b. 1935, Merjeyoun, Lebanon. Lebanese. *Class of '61* (p. 73-84).
- WAZIRI, Mohamad Rafik S. b. 1933 Mashhad, Afghanistan. Afghani. *Class of '60* (p. 67).

(Contd. on page 183)

*Potent,
dependable
broad-spectrum
therapy*

TERRAMYCIN*

BRAND OF OXYTETRACYCLINE

intramuscular

IM



FOR PATIENTS
WHO CANNOT, WILL NOT OR
SHOULD NOT TAKE ORAL MEDICATION
100 mg. vial, with
100 mg. magnesium chloride
and 2 per cent
procaine hydrochloride

FOR SEVERE
OR FULMINATING INFECTIONS, WHEN
RAPID, HIGH BLOOD LEVELS
ARE MANDATORY
250 mg. and 500 mg. vials,
with ascorbic acid buffer



intravenous

IV

Injectable Terramycin is safe and well tolerated; therapeutic results are outstanding.

TERRAMYCIN



CLINICAL
CORNERSTONE

Pfizer

WORLD'S LARGEST PRODUCER OF ANTIBIOTICS
VITAMIN-MINERAL FORMULATIONS · HORMONES

PFIZER INTERNATIONAL INC., 800 Second Avenue, New York 17, N. Y., U. S. A.

58-287

*Trademark of Chas. Pfizer & Co., Inc.

- WILLIAMSON, Suzan W. b. 1916 New York City, N. Y. American. M. D. '43 Cornell Medical School. *Professor of Obs. and Gyn.* (p. 32).
- WILSON, John L. b. 1914 Sturgis, Kentucky. American. M. D. '33 Harvard Medical School. *Professor of Surgery* (On leave).
- AL WIRR, George b. 1937, Salt, Jordan. Jordanian, *Class of '63* (p. 97).
- WOLDE, George Fikre b. 1933, Addis Ababa. Ethiopia. Ethiopian. *Class of '59* (p. 55, 61).
- WORKNEH, Fikre b. 1936 Harar, Ethiopia. Ethiopian. *Class of '62* (p. 91),
- YACOUBIAN, Hagop b. 1922, Beirut, Lebanon. Lebanese. M. D. '47, A. U. B. *Assistant Clinical Professor of Surgery* (p. 29).
- YAGHNAM, Farid C. b. 1933, Ovalle, Chile. Jordanian. M. D. '57, A. U. B. *Senior Assistant Resident in Surgery* (p. 30).
- YAKUB, Ibrahim M. b. 1933, Muharrak, Bahrein, Bahreini. *Class of '59* (p. 55, 61).
- YENIKOMSHIAN, Hovsep b. 1895, Killis, Turkey. Lebanese. M. D. '18, A. U. B., D. T. M. and H. England. '29. M. R. C. P. London '34. *Clinical Professor of Internal Medicine* (p. 24).
- YERETSIAN, Daron b. 1935, Aleppo, Syria, U. A. R. *Class of '61* (p. 73-84).
- YESSAYAN, Liza b. 1935, Beirut, Lebanon. Lebanese. *Class of '61* (p. 73-84).
- YUWAKIM, Maurice b. 1939, Ain Karem, Palestine. Jordanian. *Class of '62* (p. 84, 88, 107).
- ZAKARIYYA, Fahmi Z. b. 1933, Jableh, Syria. U. A. R. *Class of '60* (p. 67).
- ZAKHARIYYA, Alexander b. 1938, Jerusalem, Palestine. Lebanese. *Class of '62* (p. 88).
- ZARIKIAN, Sarkis b. 1935, Hama, Syria. Lebanese. *Class of '63* (p. 97).
- ZELLWEGER, Hans U. b. 1909, Lugano, Switzerland. Swiss. M. D. '34. University of Zurich. *Professor of Pediatrics* (p. 34).
- ZU'BI, Said M. b. 1930, Yaduda, Syria, U. A. R. *Class of* (p. 55, 61).



*L'homme élégant préfère toujours
les célèbres Cravates Parisiennes*

SULKA

EN VENTE

- ★ A L'EGYPTIAN & BRITISH Co. - RUE FOCH
- ★ CHEZ MAISON MAURICE SCHOUERI - SOUK TAWILÉ
- ★ CHEZ MAISON J & R MATTAR - RUE WEYGAND
- ★ ET A L'AERODROME INTERNATIONAL DE BEYROUTH

Assurez-vous de la marque
sur chaque.....

A. SULKA & Co

CRAVATE

Sole Representatives for the Middle East.

THE EGYPTIAN & BRITISH TRADING Co.

Autographs

